

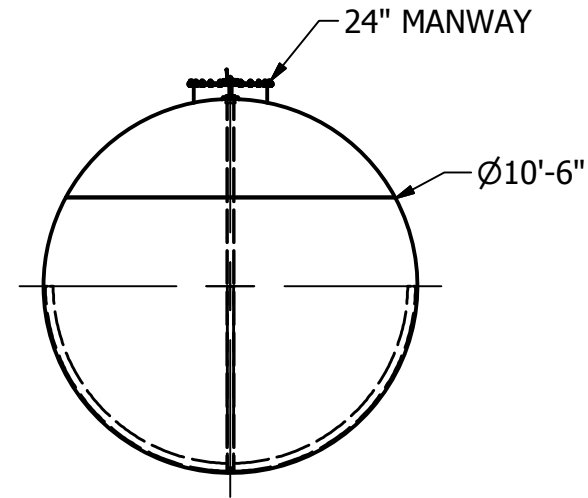

QC	LAYOUT	DIM. INSP.:	WELDER:	WELD INSP.:	COATING:	COAT. INSP.:	COMP. DATE:	HEAT #:
----	--------	-------------	---------	-------------	----------	--------------	-------------	---------

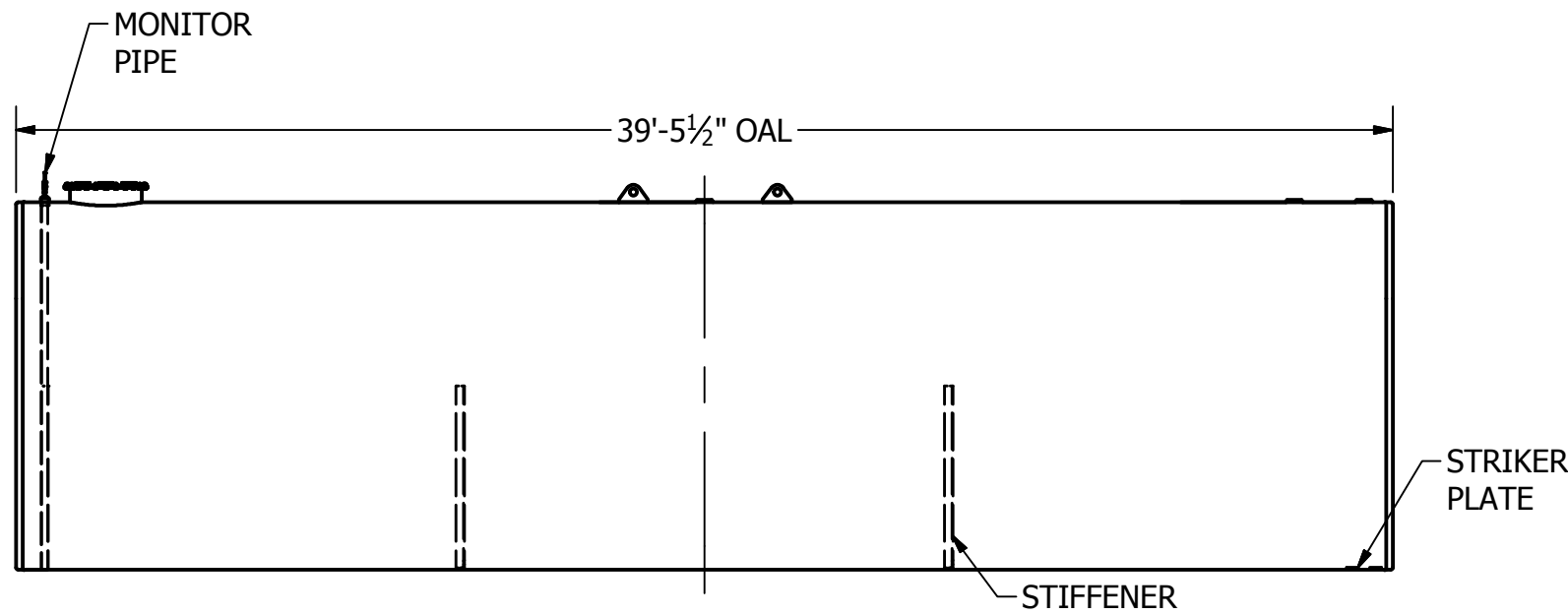
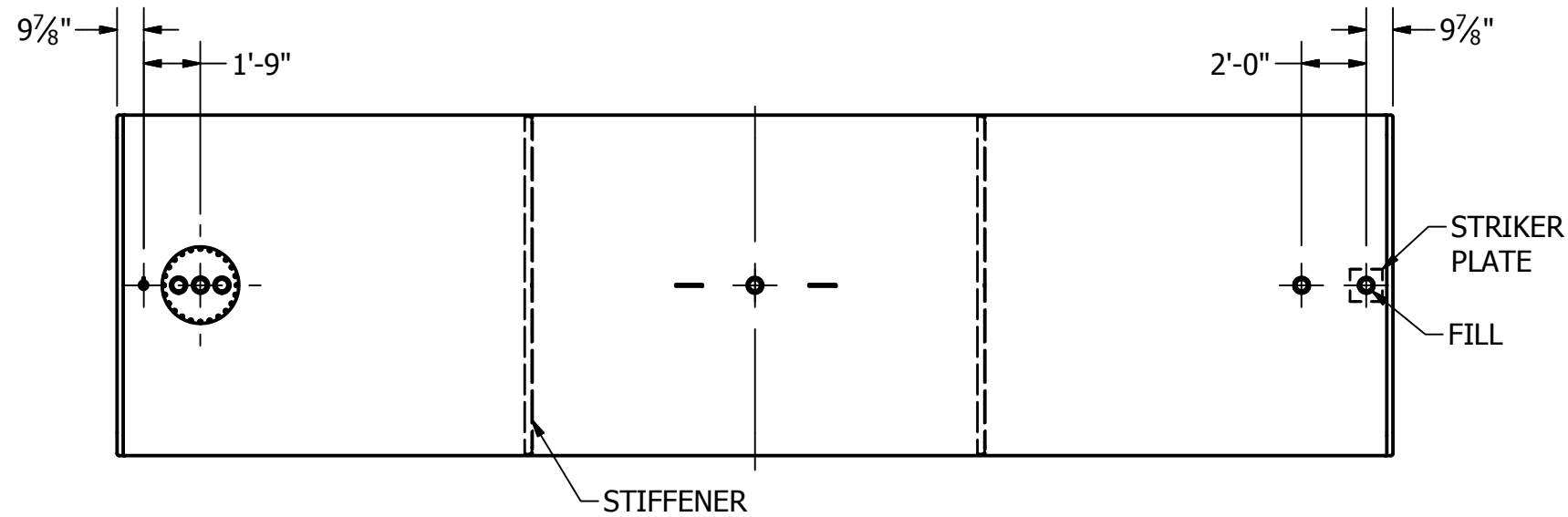

TANK SPECIFICATIONS	
ITEM	VALUE
Nominal Capacity (gal)	25000
Weight (lbs)	17630
Nominal Diameter (ft-in)	10'-6"
Nominal Length (ft-in)	39'
Head Thickness (in)	1/4"
Shell Thickness (in)	1/4"
Manway	24" Steel,Buna Gasket,Nuts/Bolts
Fittings	4" FNPT Weld Flanges, Pilot, Curved 4" FNPT Weld Flange150# (Manway)
Design Standard	Primary steel tank shall be built & tested in accordance with UL58 steel underground storage tanks for flammable & combustible liquids. Fiberglass reinforced plastic jacket shall be manufactured & applied in accordance with Plasteel® specifications & UL1746 part III, corrosion protection systems for underground storage tanks
FRP Thickness(Inches)	1/8"
Stiffener (Qty# or None)	2

DATE	REV	DESCRIPTION	PROJ#	BY
5/9/2018	0	RELEASED	DR-308	DSC
REVISION HISTORY				

 3rd ANGLE PROJECTION	4401 West Main Fargo, ND 58103 Phone: 701-282-2345 Fax: 701-282-5516 TrueNorthSteel.com		
	UNLESS OTHERWISE SPECIFIED: UNITS = INCHES TOLERANCE: LINEAR ±1/8" ANGULAR ±1/2"	DRAWN: DSC CHECKED:	
THIS DRAWING IS THE SOLE PROPERTY OF TRUENORTH STEEL INC. ANY COPIES/EDITS MADE WITHOUT THE WRITTEN CONSENT OF TRUENORTH STEEL, IS STRICTLY PROHIBITED.		PART#: 1009-0054 DESCRIPTION: Tank,H,25000,126x468,UL58,FRP,Base WEIGHT: 17627.284 lbmass SCALE: DO NOT SCALE DRAWING	SHEET: 1 OF 1