

TruePlate™ Structural Plate

Galvanized Steel and Aluminum Alloy

Sizes, Shapes and Height of Cover Tables



TrueNorth Steel®

TrueNorthSteel.com | info@TrueNorthSteel.com
866-982-9511



TruePlate™

Structural Plate

Many drainage and bridge applications exceed the size and design limitations of standard corrugated metal pipe. In these cases, structural plate can provide a solution by offering larger sizes, heavier gages and specialized shapes to meet almost any application requirement.

TrueNorth Steel® offers expert design support to engineers, owners and contractors and provides customized solutions for your drainage culvert or bridge application including:

- Large drainage or underpass structures up to 50' diameter
- Bottomless arches up to 83' span
- Box Culverts – low rise/wide span up to 35' clear span
- Bottomless structures for stream or wetlands crossings
- High fill heights and high live load applications



Advantages Of TruePlate™ Structural Plate Include:

- Design versatility
- Low installed cost relative to cast-in-place or precast concrete and small bridges
- Easily installed in difficult or remote site situations
- Designed to meet your life-cycle requirements
- Less maintenance
- No bridge expansion joints for a smooth driving surface

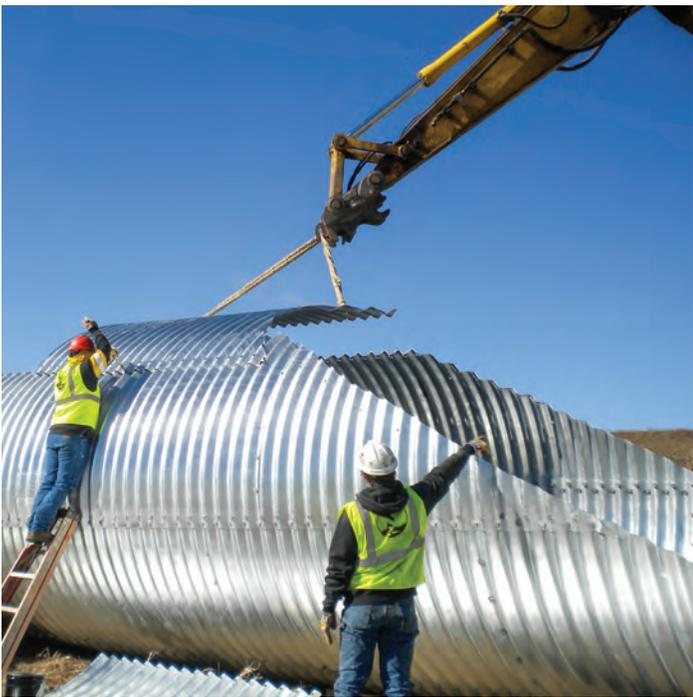

Engineering Support

The TrueNorth Steel® engineering team can support engineers, owners, and contractors using TruePlate™ galvanized steel or aluminum alloy. You can rely on our experience and resources in all aspects of the design of structural plate including: material selection; structural and hydraulic design; footing designs; detailing and installation. Additionally, we can provide fully engineered solutions stamped by professional engineers.

Contact us for:

- Specifications
- Drawings
- End treatment details
- Assembly assistance
- Installation guidance

The following are typical steps in the design of structural plate culverts, storm drains, underpasses, and bridges:

- Clearance analysis for pedestrian and vehicular passage
- Hydraulic sizing
- Structural design and resulting material properties
- Foundation design
- Environmental design and resulting material or coating selection
- Structure end treatment design
- Specifications: Material and Installation



TruePlate™ Steel and Aluminum Structural Plate

Shape	Steel 6" x 2" Corrugation	Aluminum 9" x 2.5" Corrugation	Steel 15" x 5.5" Corrugation	Applications
ROUND	Diameter	Diameter	Diameter	
	5' to 26'	6' to 21'	27' 6" to 51' 3"	Culvert, railroad, vehicular or pedestrian underpass, caisson, vertical shaft, culverts, subdrains, sewers, service tunnels, etc. All plate same radius, for medium and high fills (or trenches).
PIPE ARCH	Span x Rise	Span x Rise		
	6' 1" x 4' 7" to 20' 7" x 13' 2"	6' 7" x 5' 8" to 21' 11" x 14' 11"		Low rise culvert provides greater flow area at low elevations where headroom is limited. Has hydraulic advantages at low flows. Corner plate radius 31".
ARCH - Single Radius	Span x Rise	Span x Rise	Span x Rise	
	6' x 1' 10" to 26' x 13' 11"	6' x 1' 10" to 23' x 11' 11"	22' 11" x 11' 5" to 82' x 42'	Low rise culvert, bottomless arch, fish passage, vehicular or pedestrian underpass, corrugated footings, cast-in-place or precast concrete footings. Aesthetically pleasing low clearance and large waterway openings.
ARCH - Multiple Radius	Span x Rise		Span x Rise	
	18' 5" x 8' 4" to 50' 7" x 19' 11"		10' 5" x 3' 10" to 51' 8" x 13' 11"	Low rise - long span structures. Culverts, bridges and underpasses. Constructed on cast-in-place concrete footings or slabs.
BOX CULVERT	Span x Rise	Span x Rise		
	9' 8" x 2' 7" to 25' 5" x 10' 2"	8' 9" x 2' 6" to 35' 3" x 13' 7"		Low rise culvert, short span bridge, corrugated footings, cast-in-place or pre-cast concrete footings, full corrugated invert. Low-wide waterway enclosures, culverts, storms sewers.
UNDERPASS	Span x Rise	Span x Rise		
	5' 8" x 5' 9" to 20' 4" x 17' 9"	6' 1" x 5' 9" to 20' 5" x 17' 9"		Vehicular or pedestrian underpass. For pedestrians, livestock or vehicles.
ELLIPSE - Horizontal	Span x Rise	Span x Rise		
	7' 4" x 5' 6" to 14' 11" x 11' 2"	9' 2" x 6' 8" to 14' 11" x 11' 2"		Low rise culvert, vehicular or pedestrian underpass, grade separations.
ELLIPSE - Vertical	Span x Rise	Span x Rise		
	4' 8" x 5' 2" to 25' 0" x 27' 8"	5' 7" x 6' 3" to 20' x 22' 3"		Vehicular or Pedestrian Underpass, Culverts, sewers, service tunnels, recovery tunnels. Plates of varying radii: shop fabrication. For appearance and where backfill compaction is only moderate.

Structural Plate Meets The Following Specifications

MATERIALS

ASTM A761	Corrugated Steel Structural Plate, Zinc Coated for Field Bolted Pipe, Pipe Arches and Arches
ASTM 964	Corrugated Steel Box Culverts
ASTM B746	Corrugated Aluminum Alloy Structural Plate for Field Bolted Pipe, Pipe Arches and Arches
ASTM B864	Corrugated Aluminum Alloy Box Culverts
AASHTO M167	Corrugated Steel Structural Plate, Zinc Coated for Field Bolted Pipe, Pipe Arches and Arches
AASHTO M219	Corrugated Aluminum Alloy Structural Plate for Field Bolted Pipe, Pipe Arches and Arches

INSTALLATION

ASTM A807	Practice for Installing Corrugated Steel Structural Plate Pipe for Sewers
ASTM B789	Practice for Installing Corrugated Aluminum Structural Plate Pipe for Culverts and Sewers
AASHTO	LRFD Bridge Construction Specifications, Section 26, Metal Culverts

DESIGN

ASTM A796	Practice for Structural Design of Corrugated Steel Pipe, Pipe Arches and Arches
ASTM B790	Practice for Structural Design of Corrugated Aluminum Pipe, Pipe Arches and Arches
AASHTO	LRFD Bridge Design Specifications, Section 12, Buried Structures and Tunnels
AREMA	Manual for Railway Engineering, Section 4 Culverts

Sizes, Shapes and Height of Cover Tables

The design tables for Steel Structural Plate Pipe and Pipe Arch contained in this document are excerpted from the National Corrugated Steel Pipe Association's Corrugated Steel Pipe Design Manual. The design tables for Aluminum Structural Plate are excerpted from the original Aluminum Association Aluminum Products Drainage Manual which is no longer in publication. For more complete design information or design support for Structural Plate, please contact your TrueNorth Steel® representative.

The tables contained in this document are meant as a general reference and TrueNorth Steel® always recommends that each application should be analyzed specifically. Minimum allowable cover amounts are a function of the listed live loads whether HS-20, HS-25 or HL-93. Construction loads applied may be greater than HS-20, HS-25, HL-93 and E-80 and may require greater temporary cover.

All structural plate designs should include a thorough foundation analysis. Arch Structural

Plate and Aluminum Box Culverts require additional foundation design attention because they are often constructed on either corrugated metal footing pads, upon concrete footings or slabs. TrueNorth Steel® is available to assist with the design of any of these options.

The successful installation of any corrugated structure is highly dependent upon the backfill material and backfilling process. The National Corrugated Steel Pipe Association publishes specific backfill selection and backfill process guidance within the Corrugated Steel Pipe Design Manual. ASTM A807 also provides comprehensive installation guidance for steel structural plate and ASTM B789 provides the same guidance for aluminum structural plate.

Finally, an appropriate end treatment such as beveled ends, concrete slope collars, headwalls or scour cut-off toe walls will ensure long term stability of the structure. TrueNorth Steel® has extensive experience with this feature and all of the design requirements of structural plate.



Structural Plate Height of Cover Table of Contents

Steel 6” x 2” Corrugation

Round Structural Plate – Steel8-9

Pipe Arch Structural Plate – Steel.....10-13

Elliptical Structural Plate – Steel.14-15

Underpass Structural Plate – Steel.....16-17

Single Radius Arch Structural Plate – Steel18-19

Steel - Deep Corrugation

Round Structural Plate – Deep Corrugation – Steel 21

Single Radius Arch – Deep Corrugation – Steel 22

Arch Structural Plate – Deep Corrugation – Steel.23-24

Aluminum Structural Plate

Round, Vertical Ellipse Structural Plate – Aluminum 26

Single Radius Arch Structural Plate – Aluminum 27

Pipe Arch Structural Plate – Aluminum. 28

Underpass Structural Plate – Aluminum 29

Box Culvert Structural Plate – Aluminum 30-35

Structure Selection Examples 30



TrueNorth Steel®

TrueNorthSteel.com

info@TrueNorthSteel.com | 866-982-9511

Round Structural Plate – Steel

6" x 2" Corrugation

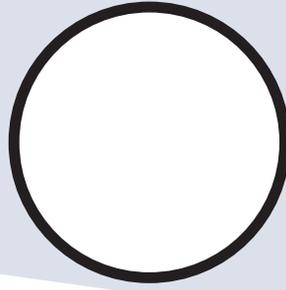

AISI-7									
Height of Cover Limits for Steel Pipe H25 Live Load • 6 x 2 Corrugation									
Diameter or Span,		Min.* Cover,	Maximum Cover (ft) for Specified Thickness (in.)						
ft	in.	in.	0.111	0.140	0.170	0.188	0.218	0.249	0.280
5.0	60	24	81	120	157	175	205	234	263
5.5	66	24	74	109	142	159	186	213	239
6.0	72	24	68	100	131	146	170	195	220
6.5	78	24	63	92	120	135	157	180	203
7.0	84	24	58	86	112	125	146	167	188
7.5	90	24	54	80	104	117	136	156	176
8.0	96	24	51	75	98	109	128	146	165
8.5	102	24	48	71	92	103	120	138	155
9.0	108	24	45	67	87	97	114	130	146
9.5	114	24	43	63	82	92	108	123	139
10.0	120	24	41	60	78	88	102	117	132
10.5	126	30	39	57	75	83	97	111	125
11.0	132	30	37	55	71	80	93	106	120
11.5	138	30	35	52	68	76	89	102	115
12.0	144	30	34	50	65	73	85	97	110
12.5	150	30	33	48	63	70	82	94	105
13.0	156	36	31	46	60	67	79	90	101
13.5	162	36	30	45	58	65	76	87	98
14.0	168	36	29	43	56	63	73	84	94
14.5	174	36	28	41	54	60	71	81	91
15.0	180	36	27	40	52	58	68	78	88
15.5	186	42	26	39	51	57	66	75	85
16.0	192	42		38	49	55	64	73	82
16.5	198	42		36	47	53	62	71	80
17.0	204	42		35	46	51	60	69	77
17.5	210	42		34	44	49	58	66	74
18.0	216	48		33	42	47	55	63	71
18.5	222	48			40	45	53	61	68
19.0	228	48			39	43	51	58	66
19.5	234	48			37	42	49	56	63
20.0	240	48			36	40	47	54	61
20.5	246	54				38	45	51	58
21.0	252	54				37	43	49	56
21.5	258	54					41	47	54
22.0	264	54					40	45	51
22.5	270	60					38	44	49
23.0	276	60						42	47
23.5	282	60						40	45
24.0	288	60						38	43
24.5	294	60						37	42
25.0	300	60							40
25.5	306	60							38
26.0	312	60							36

Excerpted from National Corrugated Steel Pipe Association
AISI – American Iron and Steel Institute

Round Structural Plate – Steel

6" x 2" Corrugation

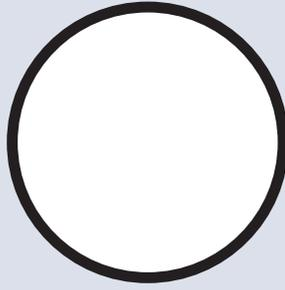

AISI-8									
Height of Cover Limits for Steel Pipe E80 Live Load • 6 x 2 Corrugation									
Diameter or Span,		Min.* Cover,	Maximum Cover (ft) for Specified Thickness (in.)						
ft	in.	in.	0.111	0.140	0.170	0.188	0.218	0.249	0.280
5.0	60	24	81	120	157	175	205	234	263
5.5	66	24	74	109	142	159	186	213	239
6.0	72	24	68	100	131	146	170	195	220
6.5	78	24	63	92	120	135	157	180	203
7.0	84	24	58	86	112	125	146	167	188
7.5	90	24	54	80	104	117	136	156	176
8.0	96	24	51	75	98	109	128	146	165
8.5	102	24	48	71	92	103	120	138	155
9.0	108	24	45	67	87	97	114	130	146
9.5	114	24	43	63	82	92	108	123	139
10.0	120	24	41	60	78	88	102	117	132
10.5	126	30	39	57	75	83	97	111	125
11.0	132	30	37	55	71	80	93	106	120
11.5	138	30	35**	52	68	76	89	102	115
12.0	144	30	34**	50	65	73	85	97	110
12.5	150	30	32**	48	63	70	82	94	105
13.0	156	36	31**	46	60	67	79	90	101
13.5	162	36	29**	45	58	65	76	87	98
14.0	168	36	28**	43	56	63	73	84	94
14.5	174	36	26**	41	54	60	71	81	91
15.0	180	36	25**	40	52	58	68	78	88
15.5	186	42	24**	39	51	57	66	75	85
16.0	192	42	23**	38	49	55	64	73	82
16.5	198	42		36	47	53	62	71	80
17.0	204	42		35	46	51	60	69	77
17.5	210	42		34	44	49	58	66	74
18.0	216	48		33	42	47	55	63	71
18.5	222	48			40	45	53	61	68
19.0	228	48			39	43	51	58	66
19.5	234	48			37	42	49	56	63
20.0	240	48			36	40	47	54	61
20.5	246	54				38	45	51	58
21.0	252	54				37	43	49	56
21.5	258	54					41	47	54
22.0	264	54					40	45	51
22.5	270	60					38	44	49
23.0	276	60						42	47
23.5	282	60						40	45
24.0	288	60						38	43
24.5	294	60						37	42
25.0	300	60							40
25.5	306	60							38
26.0	312	60							36

Notes:

* From top of pipe to bottom of tie.

** These pipe require additional minimum cover.

Pipe Arch Structural Plate – Steel

6" x 2" Corrugation

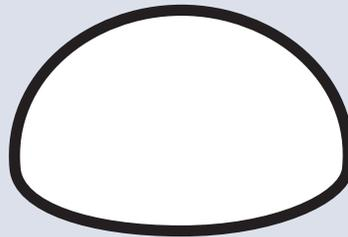

AISI-14

Height-of-Cover Limits for Structural Plate Pipe Arch • 18 in. R_C Corner Radius
H20 or H25 Live Load • 6 x 2 in. Corrugation

Size		Minimum Specified Thickness Required in.	Minimum* Cover in.	Maximum Cover (ft) Over Pipe Arch for the Following Soil Corner Bearing Capacities	
Span ft-in.	Rise ft-in.			2 tons/ft ²	3 tons/ft ²
6-1	4-7	0.111	12	19	
6-4	4-9	0.111	12	18	
6-9	4-11	0.111	12	17	
7-0	5-1	0.111	12	16	
7-3	5-3	0.111	12	16	
7-8	5-5	0.111	12	15	
7-11	5-7	0.111	12	14	
8-2	5-9	0.111	18	14	
8-7	5-11	0.111	18	13	
8-10	6-1	0.111	18	13	
9-4	6-3	0.111	18	12	
9-6	6-5	0.111	18	12	
9-9	6-7	0.111	18	12	
10-3	6-9	0.111	18	10	
10-8	6-11	0.111	18	8	
10-11	7-1	0.111	18	8	
11-5	7-3	0.111	18	8	15
11-7	7-5	0.111	18	8	15
11-10	7-7	0.111	18	7	14
12-4	7-9	0.111	24	6	12
12-6	7-11	0.111	24	6	12
12-8	8-1	0.111	24	6	11
12-10	8-4	0.111	24	6	11
13-5	8-5	0.111	24	5	11
13-11	8-7	0.111	24	5	10
14-1	8-9	0.111	24	5	10
14-3	8-11	0.111	24	5	10
14-10	9-1	0.111	24	5	10
15-4	9-3	0.111	24		9
15-6	9-5	0.111	24		9
15-8	9-7	0.111	24		9
15-10	9-10	0.111	24		9
16-5	9-11	0.111	30		9
16-7	10-1	0.111	30		9

Notes:

1. Soil bearing capacity refers to the soil in the region of the pipe corners. See Chapter 10 for design of pipe envelope at pipe corners. The remaining backfill around the pipe arch must be compacted to a specified AASHTO T-99 density of 90%.

2. Use reasonable care in handling and installation.

3. Pipe arches are typically used where the cover does not exceed 15 feet.

* Minimum covers are for H20 and H25 loads. See Table 7.8 for construction load requirements. Minimum covers are measured from top of pipe to bottom of flexible pavement or top of pipe to top of rigid pavement. Minimum cover must be maintained in unpaved traffic areas.

6" x 2" Corrugation

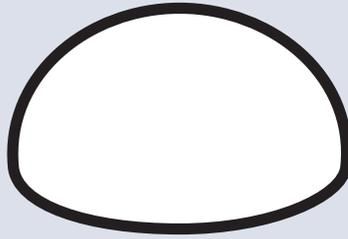

AISI-15					
Height-of-Cover Limits for Structural Plate Pipe Arch • 31 in. R_C Corner Radius H20 or H25 Live Load • 6 x 2 in. Corrugation					
Size		Minimum Specified Thickness Required in.	Minimum* Cover in.	Maximum Cover (ft) Over Pipe Arch for the Following Soil Corner Bearing Capacities	
Span ft-in.	Rise ft-in.			2 tons/ft ²	3 tons/ft ²
13-3	9-4	0.111	24	13	
13-6	9-6	0.111	24	13	
14-0	9-8	0.111	24	12	
14-2	9-10	0.111	24	12	
14-5	10-0	0.111	24	12	
14-11	10-2	0.111	24	12	
15-4	10-4	0.111	24	11	
15-7	10-6	0.111	24	11	
15-10	10-8	0.111	24	10	
16-3	10-10	0.111	30	10	
16-6	11-0	0.111	30	10	
17-0	11-2	0.111	30	10	15
17-2	11-4	0.111	30	10	15
17-5	11-6	0.111	30	10	15
17-11	11-8	0.111	30	10	14
18-1	11-10	0.111	30	9	14
18-7	12-0	0.111	30	9	14
18-9	12-2	0.111	30	9	14
19-3	12-4	0.111	30	9	13
19-6	12-6	0.140	30	9	13
19-8	12-8	0.140	30	9	13
19-11	12-10	0.140	30	9	13
20-5	13-0	0.140	36	8	13
20-7	13-2	0.140	36	8	13

Notes:

- Soil bearing capacity refers to the soil in the region of the pipe corners. See Chapter 10 for design of pipe envelope at pipe corners. The remaining backfill around the pipe arch must be compacted to a specified AASHTO T-99 density of 90%.
- Use reasonable care in handling and installation.
 - * Minimum covers are for H20 and H25 loads. See Table 7.8 for construction load requirements. Minimum covers are measured from top of pipe to bottom of flexible pavement or top of pipe to top of rigid pavement. Minimum cover must be maintained in unpaved traffic areas.

Excerpted from National Corrugated Steel Pipe Association
 AISI – American Iron and Steel Institute

Pipe Arch Structural Plate – Steel

6" x 2" Corrugation

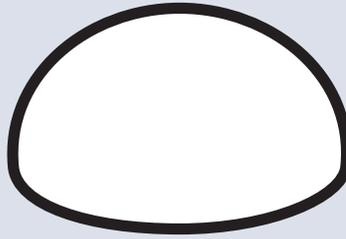

AISI-16						
Height-of-Cover Limits for Structural Plate Pipe Arch • 18 in. R_C Corner Radius E80 Live Load • 6 x 2 in. Corrugation						
Size		Minimum Specified Thickness Required in.	Minimum* Cover in.	Maximum Cover (ft) Over Pipe Arch for the Following Soil Corner Bearing Capacities		
Span ft-in.	Rise ft-in.			2 tons/ft ²	3 tons/ft ²	4 tons/ft ²
6-1	4-7	0.111	24	19		
6-4	4-9	0.111	24	15		
6-9	4-11	0.111	24	15		
7-0	5-1	0.111	24	13		
7-3	5-3	0.111	24	12		
7-8	5-5	0.111	24	12		
7-11	5-7	0.111	24	11		
8-2	5-9	0.111	24	10		
8-7	5-11	0.111	24	6		
8-10	6-1	0.111	24	5		
9-4	6-3	0.111	24		17	
9-6	6-5	0.111	24		16	
9-9	6-7	0.111	24		16	
10-3	6-9	0.111	30		15	
10-8	6-11	0.111	30		13	
10-11	7-1	0.111	30		13	
11-5	7-3	0.111	30		12	
11-7	7-5	0.140	30		12	
11-10	7-7	0.140	30		12	
12-4	7-9	0.140	30		6	
12-6	7-11	0.140	30		6	16
12-8	8-1	0.140	36		6	16
12-10	8-4	0.140	36		6	16
13-5	8-5	0.140	36			15
13-11	8-7	0.140	36			15
14-1	8-9	0.140	36			14
14-3	8-11	0.140	36			11
14-10	9-1	0.140	36			9
15-4	9-3	0.140	42			9
15-6	9-5	0.140	42			9
15-8	9-7	0.140	42			9
15-10	9-10	0.140	42			9
16-5	9-11	0.140	42			7
16-7	10-1	0.140	42			7

Notes:

- Soil bearing capacity refers to the soil in the region of the pipe corners. See Chapter 10 for design of pipe envelope at pipe corners. The remaining backfill around the pipe arch must be compacted to a specified AASHTO T-99 density of 90%.
- Use reasonable care in handling and installation.
- Pipe arches are typically used where the cover does not exceed 15 feet.

* From top of pipe to bottom of tie.

Pipe Arch Structural Plate – Steel

6" x 2" Corrugation

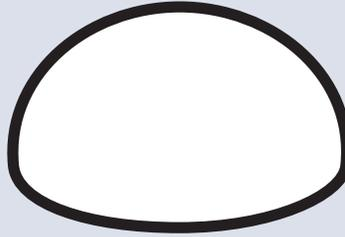

AISI-17					
Height-of-Cover Limits for Structural Plate Pipe Arch • 31 in. R_C Corner Radius E80 Live Load • 6 x 2 in. Corrugation					
Size		Minimum Specified Thickness Required in.	Minimum* Cover in.	Maximum Cover (ft) Over Pipe Arch for the Following Soil Corner Bearing Capacities	
Span ft-in.	Rise ft-in.			2 tons/ft ²	3 tons/ft ²
13-3	9-4	0.140	36	9	22
13-6	9-6	0.140	36	8	22
14-0	9-8	0.140	36	6	21
14-2	9-10	0.140	36	6	21
14-5	10-0	0.140	36	6	21
14-11	10-2	0.140	36	6	20
15-4	10-4	0.140	42	6	19
15-7	10-6	0.140	42	6	19
15-10	10-8	0.140	42	6	19
16-3	10-10	0.140	42		14
16-6	11-0	0.140	42		14
17-0	11-2	0.140	42		13
17-2	11-4	0.140	42		13
17-5	11-6	0.140	42		
17-11	11-8	0.140	48		11
18-1	11-10	0.140	48		11
18-7	12-0	0.140	48		11
18-9	12-2	0.140	48		11
19-3	12-4	0.140	48		10
19-6	12-6	0.170	48		10
19-8	12-8	0.170	48		10
19-11	12-10	0.170	48		10
20-5	13-0	0.170	48		10
20-7	13-2	0.170	48		10

Notes:

1. Soil bearing capacity refers to the soil in the region of the pipe corners. See Chapter 10 for design of pipe envelope at pipe corners. The remaining backfill around the pipe arch must be compacted to a specified AASHTO T-99 density of 90%.
 2. Use reasonable care in handling and installation.
 3. Pipe arches are typically used where the cover does not exceed 15 feet.
- *From top of pipe to bottom of tie.

Excerpted from National Corrugated Steel Pipe Association
AISI – American Iron and Steel Institute

Elliptical Structural Plate – Steel

6" x 2" Corrugation

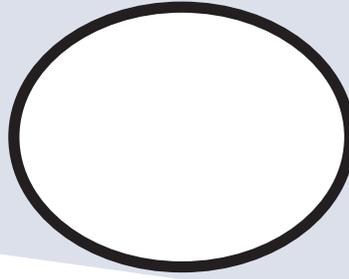

AISI-18							
Height-of-Cover Limits for Structural Plate Horizontal Elliptical Pipe H20 or H25 Live Load • 6 x 2 in. Corrugation							
Pipe Size	Span ft-in.	Rise ft-in.	R _T in.	R _S in.	Minimum* Cover in.	Minimum Specified Thickness Required in.	Maximum Cover (ft) Over Pipe for Side and Haunch Soil Bearing Capacity of 2 tons/ft ²
24 E 15	7-4	5-6	54.00	26.50	12	0.111	16
27 E 15	8-1	5-9	60.88	26.50	18	0.111	14
30 E 15	8-10	6-0	67.75	26.50	18	0.111	13
30 E 18	9-2	6-9	67.75	32.00	18	0.111	15
33 E 15	9-7	6-4	74.63	26.50	18	0.111	11
33 E 18	9-11	7-0	74.63	32.00	18	0.111	14
36 E 15	10-4	6-7	81.51	26.50	18	0.111	10
36 E 18	10-8	7-3	81.51	32.00	18	0.111	13
36 E 21	11-0	8-0	81.51	37.50	18	0.111	15
39 E 15	11-1	6-10	88.38	26.50	18	0.111	10
39 E 18	11-4	7-6	88.38	32.00	18	0.111	12
39 E 21	11-8	8-3	88.38	37.50	18	0.111	14
39 E 24	12-0	8-11	88.38	43.00	24	0.111	16
42 E 15	11-9	7-1	95.26	26.50	18	0.111	9
42 E 18	12-1	7-10	95.26	32.00	24	0.111	11
42 E 21	12-5	8-6	95.26	37.50	24	0.111	13
42 E 24	12-9	9-2	95.26	43.00	24	0.111	15
45 E 15	12-6	7-4	102.13	26.50	24	0.111	8
45 E 18	12-10	8-1	102.13	32.00	24	0.111	10
45 E 21	13-2	8-9	102.13	37.50	24	0.111	12
45 E 24	13-6	9-6	102.13	43.00	24	0.111	14
48 E 18	13-7	8-4	109.01	32.00	24	0.111	9
48 E 21	13-11	9-0	109.01	37.50	24	0.111	11
48 E 24	14-3	9-9	109.01	43.00	24	0.111	13
48 E 27	41-7	10-5	109.01	48.50	24	0.111	14
48 E 30	14-11	11-2	109.01	54.00	24	0.111	16

Notes:

1. Soil bearing capacity refers to the soil in the region of the pipe haunches. See Chapter 10 for design of pipe envelope at pipe haunches. The remaining backfill around the ellipse must be compacted to a specified AASH-TOT-99 density of 90%.
2. Use reasonable care in handling and installation.

* Minimum covers are for H20 and H25 loads. See Table 10.1 for construction load requirements. Minimum covers are measured from top of pipe to bottom of flexible pavement or top of pipe to top of rigid pavement. Minimum cover must be maintained in unpaved traffic areas.

Excerpted from National Corrugated Steel Pipe Association
AISI – American Iron and Steel Institute

6" x 2" Corrugation

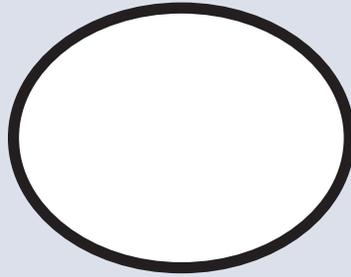

AISI-19							
Height-of-Cover Limits for Structural Plate Horizontal Elliptical Pipe E80 Live Load • 6 x 2 in. Corrugation							
Pipe Size	Span ft-in.	Rise ft-in.	R _T in.	R _S in.	Minimum* Cover in.	Minimum Specified Thickness Required in.	Maximum Cover (ft) Over Pipe for Side and Haunch Soil Bearing Capacity of 3 tons/ft ²
24 E 15	7-4	5-6	54.00	26.50	24	0.111	24
27 E 15	8-1	5-9	60.88	26.50	24	0.111	21
30 E 15	8-10	6-0	67.75	26.50	24	0.140	19
30 E 18	9-2	6-9	67.75	32.00	24	0.140	24
33 E 15	9-7	6-4	74.63	26.50	24	0.140	17
33 E 18	9-11	7-0	74.63	32.00	30	0.140	21
36 E 15	10-4	6-7	81.51	26.50	30	0.140	15
36 E 18	10-8	7-3	81.51	32.00	30	0.140	20
36 E 21	11-0	8-0	81.51	37.50	30	0.140	23
39 E 18	11-4	7-6	88.38	32.00	30	0.140	18
39 E 21	11-8	8-3	88.38	37.50	30	0.140	22
39 E 24	12-0	8-11	88.38	43.00	30	0.140	25
42 E 18	12-1	7-10	95.26	32.00	30	0.140	16
42 E 21	12-5	8-6	95.26	37.50	30	0.140	20
42 E 24	12-9	9-2	95.26	43.00	36	0.140	23
45 E 18	12-10	8-1	102.13	32.00	36	0.170	15
45 E 21	13-2	8-9	102.13	37.50	36	0.170	19
45 E 24	13-6	9-6	102.13	43.00	36	0.170	22
48 E 18	13-7	8-4	109.01	32.00	36	0.170	13
48 E 21	13-11	9-0	109.01	37.50	36	0.170	17
48 E 24	14-3	9-9	109.01	43.00	36	0.170	20
48 E 27	14-7	10-5	109.01	48.50	36	0.170	23
48 E 30	14-11	11-2	109.01	54.00	42	0.170	26

Notes:

1. Soil bearing capacity refers to the soil in the region of the pipe haunches. See Chapter 10 for design of pipe envelope at pipe haunches. The remaining backfill around the ellipse must be compacted to a specified AASH-TOT-99 density of 90%.
2. Use reasonable care in handling and installation.

* From top of pipe to bottom of tie.

Excerpted from National Corrugated Steel Pipe Association
 AISI – American Iron and Steel Institute

Underpass Structural Plate – Steel

6" x 2" Corrugation

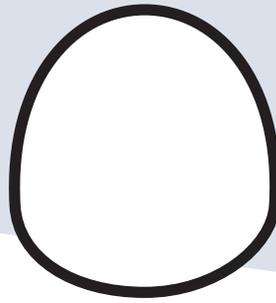

AISI-20

Height-of-Cover Limits for Structural Plate Underpass
H20 or H25 Live Load • 6 x 2 in. Corrugation

Size		R _c Corner Radius in.	Minimum Specified Thickness Required in.	Minimum* Cover in.	Maximum Cover (ft) Over Underpass for Soil Corner Bearing Capacity of 2 tons/ft ²
Span ft-in.	Rise ft-in.				
5-8	5-9	18	0.111	12	26
5-8	6-6	18	0.111	12	24
5-9	7-4	18	0.111	12	24
5-10	7-8	18	0.111	12	24
5-10	8-2	18	0.111	12	24
12-2	11-0	38	0.111	24	22
12-11	11-2	38	0.111	24	20
13-2	11-10	38	0.111	24	20
13-10	12-2	38	0.111	24	19
14-1	12-10	38	0.111	24	19
14-6	13-5	38	0.111	24	19
14-10	14-0	38	0.111	24	19
15-6	14-4	38	0.111	24	15
15-8	15-0	38	0.111	24	15
16-4	15-5	38	0.140	36	15
16-5	16-0	38	0.140	36	14
16-9	16-3	38	0.140	36	14
17-3	17-0	47	0.140	36	17
18-4	16-11	47	0.170	36	16
19-1	17-2	47	0.170	36	15
19-6	17-7	47	0.170	36	15
20-4	17-9	47	0.188	36	14

Notes:

1. Soil bearing capacity refers to the soil in the region of the pipe corners. See Chapter 10 for design of pipe envelope at pipe corners. The remaining backfill around the underpass must be compacted to a specified AASHTO T-99 density of 90%.

2. Use reasonable care in handling and installation.

* Minimum covers are for H20 and H25 loads. See Table 10.1 for heavy construction load requirements. Minimum covers are measured from top of pipe to bottom of flexible pavement or top of pipe to top of rigid pavement. Minimum cover must be maintained in unpaved traffic areas.

Underpass Structural Plate – Steel

6" x 2" Corrugation

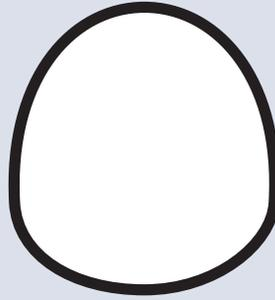

AISI-21					
Height-of-Cover Limits for Structural Plate Underpass E80 Live Load • 6 x 2 in. Corrugation					
Size		R _c Corner Radius in.	Minimum Specified Thickness Required in.	Minimum* Cover in.	Maximum Cover (ft) Over Underpass for Soil Corner Bearing Capacity of 2 tons/ft ²
Span ft-in.	Rise ft-in.				
5-8	5-9	18	0.111	24	26
5-8	6-6	18	0.111	24	24
5-9	7-4	18	0.111	24	24
5-10	7-8	18	0.111	24	24
5-10	8-2	18	0.111	24	24
12-2	11-0	38	0.140	36	22
12-11	11-2	38	0.140	36	20
13-2	11-10	38	0.140	36	20
13-10	12-2	38	0.140	36	17
14-1	12-10	38	0.140	36	17
14-6	13-5	38	0.140	36	19
14-10	14-0	38	0.140	36	19
15-6	14-4	38	0.140	48	12
15-8	15-0	38	0.140	48	13
16-4	15-5	38	0.140	48	13
16-5	16-0	38	0.140	48	11
16-9	16-3	38	0.140	48	11
17-3	17-0	47	0.140	48	15
18-4	16-11	47	0.170	48	14
19-1	17-2	47	0.170	48	13
19-6	17-7	47	0.170	48	13
20-4	17-9	47	0.188	48	12

Notes:
 1. Soil bearing capacity refers to the soil in the region of the pipe corners. See Chapter 10 for design of pipe envelope at pipe corners. The remaining backfill around the underpass must be compacted to a specified AASHTO T-99 density of 90%.
 2. Use reasonable care in handling and installation.
 * From top of pipe to bottom of tie.

Excerpted from National Corrugated Steel Pipe Association
 AISI – American Iron and Steel Institute

Single Radius Arch Structural Plate – Steel

6" x 2" Corrugation



AISI-22								
Height-of-Cover Limits for Structural Plate Arches H20 or H25 Live Load • 6 x 2 in. Corrugation								$\frac{\text{Rise}}{\text{Span}} \geq 0.30$
Span, ft	Min.* Cover, in.	Maximum Cover (ft) for Specified Thickness (in.)						
		0.111	0.140	0.170	0.188	0.218	0.249	0.280
5	12	81	120	157	176	205	234	264
6	12	68	101	131	146	171	195	220
7	12	58	86	112	125	146	168	188
8	12	51	75	98	111	128	146	165
9	24	45	67	87	97	114	130	146
10	24	40	60	78	87	102	117	132
11	24	37	54	71	79	93	106	120
12	24	34	50	65	73	85	97	110
13	24	31	46	60	67	79	90	101
14	24	29	43	56	62	73	83	94
15	24	27	40	52	58	68	78	88
16	24	25	37	49	54	64	73	82
17	36	24	35	45	51	60	68	77
18	36	23	33	42	47	55	63	71
19	36	18	31	38	43	50	58	65
20	36		28	35	40	47	53	60
21	36		27	32	36	43	49	56
22	36		21	31	33	39	45	51
23	36			27	31	36	41	46
24	36			21	28	33	38	43
25	48				22	31	35	39
26	48					24	32	35

Notes:
 1. Arches with R/S less than 0.30 require special design.
 * Minimum covers are for H20 and H25 loads. See Table 10.1 for heavy construction load requirements. Minimum covers are measured from top of pipe to bottom of flexible pavement or top of pipe to top of rigid pavement. Minimum cover must be maintained in unpaved traffic areas.

Excerpted from National Corrugated Steel Pipe Association
 AISI – American Iron and Steel Institute

Single Radius Arch Structural Plate – Steel

6" x 2" Corrugation



AISI-23								
Height-of-Cover Limits for Structural Plate Arches							$\frac{\text{Rise}}{\text{Span}} \geq 0.30$	
E80 Live Load • 6 x 2 in. Corrugation								
Span, ft	Min.* Cover, in.	Maximum Cover (ft) for Specified Thickness (in.)						
		0.111	0.140	0.170	0.188	0.218	0.249	0.280
5	24	81	120	157	176	205	234	264
6	24	68	101	131	146	171	195	220
7	24	58	86	112	125	146	168	188
8	24	51	75	98	111	128	146	165
9	24	45	67	87	97	114	130	146
10	24	40	60	78	87	102	117	132
11	30	37	54	71	79	93	106	120
12	30	34**	50	65	73	85	97	110
13	36	31**	46	60	67	79	90	101
14	36	29**	43	56	62	73	83	94
15	36	24**	40	52	58	68	78	88
16	48	23**	37	49	54	64	73	82
17	48	16**	35	45	51	60	68	77
18	48	14**	35	42	47	55	63	71
19	48	13**	31	37	43	50	58	65
20	48		28	33	40	47	53	60
21	60		20	31	35	43	49	56
22	60		16	27	31	39	45	51
23	60			21	28	35	41	46
24	60			17	22	31	37	43
25	60				19	24	33	39
26	60					21	24	35

Notes:
 1. Arches with R/S less than 0.30 require special design.
 * From top of pipe to bottom of tie.
 ** These structural plate arches require additional minimum cover.

Excerpted from National Corrugated Steel Pipe Association
 AISI – American Iron and Steel Institute

Deep Corrugated Structural Plate

Deep corrugated Steel Structural Plate presents owners, engineers and contractors with a material exhibiting deep corrugations resulting in a very strong and stiff section. This section lends itself well to large diameter and longer span structures.

The following pages describe common structure sizes and shapes that may be constructed using deep corrugated Steel Structural Plate. Due to the complexity and critical nature of these large structures, TrueNorth Steel® recommends a case-by-case analysis of each structure under consideration. Contact your TrueNorth Steel® representative for assistance.



Round Structural Plate – Deep Corrugation – Steel

15" x 5-1/2" Corrugation

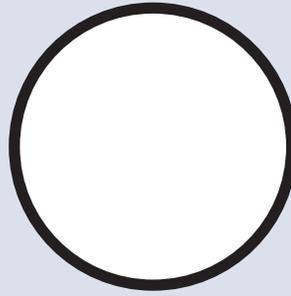

Table 2.39

Structural plate long span round⁽¹⁾
 15 x 5 1/2 in. corrugation — bolted seams

Inside Diameter ft - in.	Periphery S*	End Area ft ²
27 - 6	66	596
28 - 4	68	634
29 - 3	70	672
30 - 1	72	712
30 - 11	74	752
31 - 9	76	794
32 - 7	78	837
33 - 5	80	881
34 - 4	82	926
35 - 2	84	973
36 - 0	86	1020
36 - 10	88	1069
37 - 8	90	1119
39 - 5	94	1221
41 - 1	98	1329
42 - 10	102	1441
44 - 6	106	1557
46 - 2	110	1678
47 - 11	114	1804
49 - 7	118	1934
51 - 3	122	2069

Note: 1. All dimensions are to the inside crest and subject to manufacturing tolerances.
 2. Other sizes are available.
 3. All structures should be reviewed based on live load and geotechnical conditions

*S = 16 in.

Excerpted from National Corrugated Steel Pipe Association

Single Radius Arch – Deep Corrugation – Steel

15" x 5-1/2" Corrugation

Table 2.40

Deep Corrugated Arches — Sizes and layout details ⁽¹⁾
15 x 5-1/2 in corrugation profile — bolted seams

Span (ft-in.)	Total Rise (ft-in.)	End Area (ft ²)	Inside Radius (ft-in.)	Total S*
22' 11"	11' 5"	207	11' 5"	27
23' 9"	11' 11"	222	11' 11"	28
24' 8"	12' 4"	238	12' 4"	29
25' 1"	12' 6"	255	12' 9"	30
26' 4"	13' 2"	272	13' 2"	31
27' 2"	13' 7"	291	13' 7"	32
28' 1"	14' 0"	309	14' 0"	33
28' 10"	14' 5"	327	14' 5"	34
29' 9"	14' 10"	347	14' 10"	35
30' 7"	15' 3"	367	15' 3"	36
31' 5"	15' 9"	387	15' 9"	37
32' 3"	16' 2"	409	16' 2"	38
33' 2"	16' 6"	431	16' 7"	39
34' 0"	17' 0"	453	17' 0"	40
35' 8"	17' 10"	499	17' 10"	42
37' 4"	18' 8"	548	18' 6"	44
39' 1"	19' 6"	600	19' 6"	46
40' 9"	20' 4"	652	20' 4"	48
42' 6"	21' 3"	708	21' 3"	50
44' 2"	22' 1"	765	22' 1"	52
45' 10"	22' 11"	826	22' 11"	54
49' 3"	24' 11"	953	24' 7"	58
50' 11"	25' 6"	1019	25' 6"	60
52' 8"	26' 4"	1088	26' 4"	62
54' 8"	27' 2"	1159	27' 2"	64
56' 6"	28' 4"	1234	28' 3"	66
57' 8"	28' 10"	1309	28' 10"	68
59' 5"	29' 9"	1387	29' 9"	70
62' 10"	31' 5"	1677	31' 5"	74
66' 3"	33' 1"	1722	33' 2"	78
67' 11"	34' 0"	1812	34' 0"	80
69' 7"	34' 10"	1903	34' 9"	82
73' 0"	36' 6"	2094	36' 6"	86
74' 8"	37' 4"	2191	37' 4"	88
78' 9"	39' 6"	2448	39' 4"	93
82' 0"	41' 0"	2641	41' 0"	96

Note: 1. All dimensions are to the inside crest and subject to manufacturing tolerances.
2. Other sizes are available.
3. All structures should be reviewed based on live load and geotechnical conditions.

*S = 16 in.

15" x 5-1/2" Corrugation



Table 2.41

Structural plate multi-radius arches — size and layout details
15 x 5-1/2 in. corrugations — bolted seams

Max Span (ft-in.)	Bottom Span (ft-in.)	Total Rise (ft-in.)	End Area (ft ²)	Inside Radius Side (in.)	Inside Radius Crown (in.)	Return Angle degrees	Total S*
26' 3"	26' 3"	11' 9"	253.3	135	391	2.3	30
29' 6"	29' 6"	12' 4"	303.0	135	391	0	33
29' 3"	28' 7"	16' 11"	437.8	135	391	9.6	40
31' 2"	31' 0"	13' 0"	339.5	135	391	6.5	35
32' 10"	32' 8"	13' 0"	356.7	135	391	5.7	36
32' 10"	31' 11"	14' 11"	419.0	135	391	15.6	39
32' 10"	31' 9"	17' 7"	506.5	135	391	10.1	43
34' 5"	34' 4"	13' 9"	374.0	135	391	4.8	37
36' 1"	35' 11"	13' 9"	414.7	135	391	10.1	39
36' 1"	35' 1"	15' 8"	482.9	135	391	0	42
36' 1"	35' 3"	19' 3"	605.7	147	391	10.1	47
37' 9"	37' 7"	13' 10"	433.3	135	391	6.1	40
39' 4"	39' 3"	14' 0"	452.3	135	391	5	41
39' 4"	38' 8"	18' 6"	614.6	174	391	12.8	47
39' 4"	38' 0"	20' 0"	685.4	147	391	11.3	50
41' 0"	40' 10"	14' 9"	497.9	135	391	7.2	43
42' 8"	42' 6"	14' 11"	518.6	135	391	5.9	44
42' 8"	41' 10"	19' 4"	693.1	174	391	13.8	50
42' 8"	41' 6"	21' 2"	775.7	163	391	10.6	53
44' 3"	44' 2"	15' 2"	539.5	135	391	4.5	45
45' 11"	45' 10"	16' 0"	590.7	135	391	0	47
45' 11"	45' 6"	21' 6"	817.1	214	391	0	54
45' 11"	44' 9"	23' 0"	899.5	178	391	10.9	57
47' 7"	47' 4"	16' 11"	644.4	135	391	8	49
49' 3"	49' 1"	17' 2"	669.0	135	391	6.2	50
49' 3"	48' 6"	23' 0"	939.9	214	391	11.6	58
49' 3"	48' 1"	24' 1"	999.9	186	391	10.6	60
50' 10"	50' 8"	18' 1"	727.1	135	391	7.5	52
52' 6"	52' 4"	16' 2"	693.9	135	548	7.5	52
52' 6"	52' 1"	21' 10"	962.4	214	548	8.9	59
52' 6"	51' 0"	26' 2"	1195.9	194	548	10.4	66
54' 2"	53' 10"	16' 11"	751.1	135	548	9.5	54
55' 9"	55' 7"	17' 2"	775.2	135	548	8.2	55
55' 9"	55' 6"	22' 1"	1022.1	214	548	7.6	61
55' 9"	54' 0"	27' 10"	1345.2	202	548	11.1	70

Note: 1. All dimensions are to the inside crest and subject to manufacturing tolerances.
 2. Other sizes are available.
 3. All structures should be reviewed based on live load and geotechnical conditions.

*S = 16 in.

Arch Structural Plate – Deep Corrugation – Steel (Continued)

15" x 5-1/2" Corrugation



Table 2.41 *continued*

Structural plate multi-radius arches — size and layout details
15 x 5-1/2 in. corrugations — bolted seams

Max Span (ft-in.)	Bottom Span (ft-in.)	Total Rise (ft-in.)	End Area (ft ²)	Inside Radius Side (in.)	Inside Radius Crown (in.)	Return Angle degrees	Total S*
57' 5"	57' 3"	17' 4"	799.6	135	548	6.8	56
59' 1"	58' 10"	18' 2"	862.6	135	548	8.7	58
59' 1"	58' 8"	23' 0"	1121.2	214	548	8.3	64
60' 8"	60' 6"	18' 5"	889.0	135	548	7.1	59
62' 4"	62' 1"	19' 4"	956.0	135	548	8.8	61
62' 4"	62' 1"	23' 3"	1185.1	214	548	6.7	66
64' 0"	63' 10"	19' 7"	984.4	135	548	7.1	62
65' 7"	65' 4"	20' 6"	1055.9	135	548	8.6	64
65' 7"	65' 4"	24' 4"	1293.5	214	548	7	69
67' 3"	67' 1"	20' 10"	1086.5	135	548	6.6	65
68' 11"	68' 6"	27' 9"	1553.5	253	548	7.4	75
70' 6"	70' 4"	22' 9"	1240.4	135	548	8.8	69
72' 2"	71' 11"	19' 5"	1121.5	135	745	8.6	68
72' 2"	71' 10"	26' 9"	1607.2	253	745	7.7	77
73' 10"	73' 5"	20' 3"	120.2	135	745	10.5	70
75' 5"	75' 1"	22' 10"	1394.2	174	745	8.9	74
75' 5"	74' 11"	29' 3"	1837.1	273	745	8.9	82
77' 0"	76' 10"	23' 0"	1426.6	174	745	7.8	75
78' 9"	78' 4"	23' 10"	1510.6	174	745	9.3	77
78' 9"	78' 4"	29' 6"	1918.0	273	745	7.8	84
80' 5"	80' 0"	24' 0"	1545.0	174	745	8.1	78
82' 0"	81' 10"	24' 4"	1580.0	174	745	6.9	79
82' 0"	81' 6"	30' 6"	2053.2	273	745	8.2	87
83' 8"	83' 4"	25' 2"	1669.4	174	745	8.2	81

Note: 1. All dimensions are to the inside crest and subject to manufacturing tolerances.
2. Other sizes are available.
3. All structures should be reviewed based on live load and geotechnical conditions.

*S = 16 in.

Excerpted from National Corrugated Steel Pipe Association

Aluminum Structural Plate Design and Height of Cover Tables

Aluminum Structural Plate presents a highly durable material and provides extended design life in corrosive conditions. Utilized extensively since the 1960's, this product has a proven history of successful usage in critical highway installations.

Aluminum Structural Plate is designed using ASTM B 746 and the corresponding AASHTO Standard Specifications for Highway Bridges Sec. 12. The information on the following pages follow adheres to these design standards. Each proposed construction site should be carefully analyzed and checked to ensure that live and dead load conditions correspond to those used in these height-of-cover tables. TrueNorth Steel® is available to assist with your analysis.

Because Aluminum Structural Plate exhibits distinctly different material properties than steel, many of the designs require the use of rib stiffeners in combination with the 9" x 2.5"

corrugated section to provide additional bending resistance. The following tables show when rib stiffeners are required, what type of rib stiffeners are required and rib stiffener spacing. Together, the rib stiffener and the corrugated section create a very strong composite section.

Aluminum Box Culverts are very low profile structures designed to address specific ranges of live and dead load conditions, thus there are a relatively large number of design configurations described in the height of cover tables found in the following pages. It is important that the live load conditions be well defined and that the minimum and maximum cover be adhered to closely.

TrueNorth Steel® is well versed in the design, specification and construction of aluminum structural plate structures. Contact your local representative for support and cost estimates.



Round, Vertical Ellipse Structural Plate – Aluminum

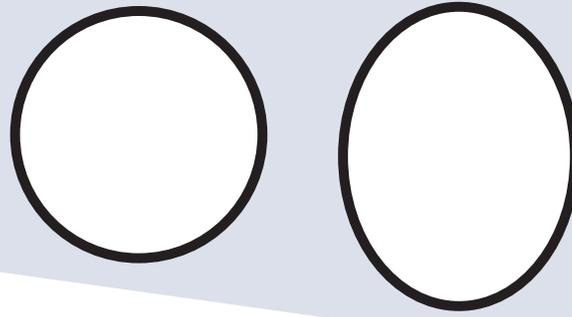

TABLE 3-1. ROUND STRUCTURES (H-20, HS-20 LIVE LOAD)

Metal Thickness (Inches) — Reinforcing Rib Type-Rib Spacing (Inches) (Maximum Cover — Ft.)									Ellipse Dimensions (Inches)	
Diameter Ft.-In.	Round (Inches)	Approx. Area Sq. Ft.	Minimum Height-of-Cover (Feet)						Span	Rise
			1.25	1.50	2.00	2.50	3.00	3.50		
6-0	72	27.5	.125 (37)	.125 (37)	.125 (37)	.125 (37)	.125 (37)	.125 (37)	67	75
6-6	78	32.4	.175	.125	.125	.125	.125	.125	73	81
7-0	84	37.8	(50)	(32)	(32)	(32)	(32)	(32)	79	88
7-6	90	43.6	.250	.150	.125	.125	.125	.125	85	94
8-0	96	49.7	(64)	(37)	(28)	(28)	(28)	(28)	91	101
8-6	102	56.3		.200	.125	.125	.125	.125	97	107
9-0	108	63.3		(45)	(25)	(25)	(25)	(25)	103	114
9-6	114	70.7			.125	.125	.125	.125	109	120
10-0	120	78.5			(22)	(22)	(22)	(22)	115	127
10-6	126	86.7	.150-II-9	.125-II-18	.125-II-27	.125	.125	.125	120	133
11-0	132	95.4	(27)	(20)	(20)	(20)	(20)	(20)	126	139
11-6	138	104.4		.125-II-9	.125-II-27	.125	.125	.125	132	146
12-0	144	113.9		(18)	(18)	(18)	(18)	(18)	138	152
12-6	150	123.7		.150-II-9	.125-II-27	.150	.125	.125	142	157
13-0	156	134.0		(23)	(17)	(23)	(17)	(17)	148	164
13-6	162	144.7		.200-II-9	.125-II-18	.125-II-27	.150	.150	153	170
14-0	168	155.7		(29)	(16)	(16)	(21)	(21)	159	176
14-6	174	167.2		.250-II-9	.125-II-9	.125-II-27	.125-II-27	.125-II-54	165	183
15-0	180	179.1		(34)	(15)	(15)	(15)	(15)	171	189
15-6	186	191.4			.125-II-9	.125-II-27	.150-II-54	.150-II-54	177	195
16-0	192	204.2			(14)	(14)	(18)	(18)	182	202
16-6	198	217.3			.150-II-9	.150-II-27	.150-II-27	.150-II-27	189	209
17-0	204	230.8			(17)	(17)	(17)	(17)	195	215
17-6	210	274.8	.200-VI-9	.175-VI-9	.175-IV-18	.175-II-27	.175-II-54	.175-II-54	200	222
18-0	216	259.1	(22)	(19)	(19)	(19)	(19)	(19)	206	228
18-6	222	273.9		.175-VI-9	.175-VI-18	.175-IV-27	.175-II-54	.175-II-54	212	235
19-0	228	289.1		(18)	(18)	(18)	(18)	(18)	217	241
19-6	234	304.7		.200-VI-9	.200-VI-18	.200-IV-27	.200-IV-54	.200-IV-54	224	247
20-0	240	321.0		(20)	(20)	(20)	(20)	(20)	229	254
20-6	246	337.0		.225-VI-9	.225-VI-18	.225-IV-27	.225-II-27	.225-II-27	235	260
21-0	252	354.0		(22)	(22)	(22)	(22)	(22)	241	267

Notes for Aluminum Structural Plate HOC Tables:

1. Table based on AASHTO Sec. 12 Standard Specifications for Highway Bridges.
2. H-20, HS-20 Live Load (Contact your local TrueNorth Steel® representative for H-25, HS-25 and HL-93 Loading).
3. Minimum cover is defined as the vertical distance from the top of the corrugated structure to the bottom of flexible or top of rigid pavement.
4. Minimum cover for heavy off-road construction equipment loads must be checked.
5. Greater cover heights possible with heavier gage and rib combinations.
6. Dimensions are to inside corrugation crests and are subject to manufacturing tolerances.
7. Areas shown are for round pipe. Areas for vertical ellipses are slightly less

Example
Corresponds to the dashed line in chart

Type II Ribs

.125"

9"

1. Require 12' 0" diameter
2. 1.5' cover from top of pipe to bottom of asphalt pavement
3. Result: Plate thickness .125"
Type II Ribs 9" on center
Max. cover 18'

TABLE 3-2. ARCH STRUCTURES (H-20, HS-20 LIVE LOAD)

Metal Thickness (Inches) — Reinforcing Rib Type-Rib Spacing (Inches)								
Span Ft.-In.	Rise Ft.-In.	Approx. Area Sq. Ft.	(Maximum Cover-Ft.) Minimum Height of Cover (Feet)					
			1.25	1.50	2.00	2.50	3.00	3.50
6-0	1-10	7.8	0.125	.125	.125	.125	.125	.125
	2-4	10.2	(37)	(37)	(37)	(37)	(37)	(37)
	2-9	12.6						
7-0	3-2	14.9						
	2-4	12.0	.175	.125	.125	.125	.125	.125
	2-10	14.8	(50)	(32)	(32)	(32)	(32)	(32)
8-0	3-3	17.5						
	3-8	20.3						
	2-11	17.0	.250	.150	.125	.125	.125	.125
9-0	3-4	20.2	(64)	(37)	(28)	(28)	(28)	(28)
	4-2	26.4						
	2-11	19.1		.200	.125	.125	.125	.125
10-0	3-10	26.3		(45)	(25)	(25)	(25)	(25)
	4-8	33.4						
	3-6	25.3	.125-II-9	.125-II-18	.125	.125	.125	.125
11-0	4-5	33.3	(22)	(22)	(22)	(22)	(22)	(22)
	5-2	41.2						
	3-6	27.8		.125-II-18	.125-II-27	.125	.125	.125
12-0	4-6	36.8		(20)	(20)	(20)	(20)	(20)
	5-9	49.9						
	4-1	35.3		.125-II-9	.125-II-27	.125	.125	.125
13-0	5-0	45.0		(18)	(18)	(18)	(18)	(18)
	6-3	59.3						
	4-1	38.1		.150-II-9	.125-II-27	.150	.125	.125
14-0	5-1	48.9		(23)	(17)	(23)	(17)	(17)
	5-11	59.3						
	6-9	69.5						
15-0	4-8	46.9		.200-II-9	.125-II-18	.125-II-27	.125	.125
	5-7	58.4		(29)	(16)	(16)	(16)	(16)
	6-5	69.5						
16-0	7-3	80.6						
	4-8	50.0		.250-II-9	.125-II-9	.125-II-27	.125	.125
	5-8	62.6		(34)	(15)	(15)	(15)	(15)
17-0	6-7	74.7						
	7-5	86.5						
	7-9	92.5						
18-0	5-3	60.0			.125-II-9	.125-II-27	.150	.125
	6-2	73.3			(14)	(14)	(18)	(14)
	7-1	86.2						
19-0	7-11	98.9						
	8-3	105.2						
	5-3	63.5			.225-II-18	.150-II-27	.175	.150
20-0	6-3	77.9			(17)	(17)	(20)	(17)
	7-2	91.7						
	8-0	105.2						
21-0	8-10	118.7						
	5-9	74.8	.200-VI-9	.150-VI-9	.175-IV-18	.125-IV-27	.200	.175
	6-9	89.9	(22)	(16)	(19)	(12)	(22)	(19)
22-0	7-8	104.5						
	8-6	118.8						
	8-11	125.9						
23-0	6-4	86.9		.150-VI-9	.125-VI-18	.125-IV-27	.125-IV-54	.125-IV-54
	7-4	102.7		(15)	(11)	(11)	(11)	(11)
	8-2	118.0						
24-0	9-0	133.2						
	9-5	140.7						
	6-4	91.2		.150-VI-9	.150-VI-9	.150-IV-27	.175-II-54	.200
25-0	7-4	108.4		(15)	(15)	(15)	(16)	(20)
	8-3	124.4						
	9-2	140.4						
26-0	10-0	156.3						
	10-4	164.2						
	6-4	95.4		.175-VI-9	.175-VI-18	.175-IV-18	.175-II-54	.225
27-0	7-5	113.5		(16)	(16)	(16)	(16)	(22)
	8-4	130.7						
	9-3	147.6						
28-0	10-1	164.3						
	10-10	181.0						
	6-11	109.2		.225-VI-9	.175-VI-18	.175-IV-18	.175-IV-27	.250
29-0	8-0	127.9		(21)	(16)	(16)	(16)	(23)
	8-11	146.0						
	9-9	163.6						
30-0	10-7	181.1						
	11-5	198.6						
	7-6	123.8			.250-VI-18	.250-VI-18	.225-IV-54	.250-II-27
31-0	8-0	133.6			(23)	(17)	(20)	(22)
	8-6	143.2						
	8-11	152.7						
32-0	9-5	162.0						
	9-10	171.3						
	10-3	180.5						
33-0	10-8	189.6						
	11-1	198.8						
	11-6	207.9						
34-0	11-11	217.1						



- Notes for Aluminum Structural Plate HOC Tables:
1. Tables based upon AASHTO Sec. 12 Standard Specifications for Highway Bridges.
 2. H-20, HS-20 Live Loads. (Contact TrueNorth Steel® for HL-93.)
 3. Minimum cover is defined as the vertical distance from the top of the corrugated structure to the bottom of flexible or top of rigid pavement.
 4. Minimum cover for off highway construction loads must be checked.
 5. Minimum cover heights < span/8 determined by moment capacity analysis.
 6. Greater cover heights possible with other plate thickness/rib combinations.
 7. Arch footing reaction are available upon request.
 8. TrueNorth Steel® can supply footing dimensions and design upon request.

TABLE 3-3. PIPE-ARCH STRUCTURES (H-20, HS-20 LIVE LOAD)

Metal Thickness (Inches) — Reinforcing Rib Type — Rib Spacing (Inches) (Maximum Cover-Ft.)								
Span Ft.-In.	Rise Ft.-In.	Approx. Area Sq. Ft.	Minimum Height-of-Cover (Feet)					
			1.25	1.50	2.00	2.50	3.00	3.50
6-7	5-8	29.6	.175	.125	.125	.125	.125	.125
6-11	5-9	31.9	(24)	(24)	(24)	(24)	(24)	(24)
7-3	5-11	34.3	.250	.150	.125	.125	.125	.125
7-9	6-0	36.8	(19)	(19)	(19)	(19)	(19)	(19)
8-1	6-1	39.3						
8-5	6-3	41.9		.200	.125	.125	.125	.125
8-10	6-4	44.5		(16)	(16)	(16)	(16)	(16)
9-3	6-5	47.1	.125-II-9	.125-II-27	.125	.125	.125	.125
9-7	6-6	49.9	(15)	(15)	(15)	(15)	(15)	(15)
9-11	6-8	52.7						
10-3	6-9	55.5		.150-II-18	.125-II-27	.125	.125	.125
10-9	6-10	58.4		(13)	(13)	(13)	(13)	(13)
11-1	7-0	61.4						
11-5	7-1	64.4		.125-II-9	.125-II-27	.125	.125	.125
11-9	7-2	67.5		(13)	(13)	(13)	(13)	(13)
12-3	7-3	70.5			.125-II-27	.150	.125	.125
12-7	7-5	73.7			(11)	(11)	(11)	(11)
12-11	7-6	77.0						
13-1	8-2	83.0						
13-1	8-4	86.8						
14-0	8-5	90.3			.125-II-18	.125-II-27	.125	.125
14-0	8-7	94.2			(10)	(10)	(10)	(10)
14-0	9-5	101.5						
14-3	9-7	105.7			.125-II-9	.125-II-27	.125	.125
14-8	9-8	109.9			(11)	(11)	(11)	(11)
14-11	9-11	114.2						
15-4	10-0	118.6			.125-II-9	.125-II-27	.150	.125
15-8	10-2	123.1			(9)	(9)	(9)	(9)
16-1	10-4	127.6						
16-4	10-6	132.3						
16-9	10-8	136.9			.125-VI-27	.125-II-18	.125-II-54	.150
17-0	10-10	141.8			(8)	(8)	(8)	(8)
17-3	11-0	146.7						
17-9	11-2	151.6						
18-0	11-4	156.7			.125-VI-27	.125-IV-27	.125-IV-54	.175
18-5	11-6	161.7			(8)	(8)	(8)	(8)
18-8	11-8	167.0						
19-2	11-9	172.2			.150-IV-9	.150-IV-27	.150-IV-54	.200
19-5	12-0	177.6			(7)	(7)	(7)	(7)
19-10	12-1	182.9						
20-1	12-3	188.5			.175-IV-9	.175-IV-27	.175-IV-54	.200
20-1	12-6	194.4			(7)	(7)	(7)	(7)
20-1	13-11	199.7						
20-7	14-3	205.5						
20-10	12-7	211.2						
21-1	12-9	216.6			.150-VI-18	.175-IV-18	.150-IV-54	.150-IV-54
21-6	12-11	224.0			(7)	(7)	(7)	(7)
21-6	14-7	241.5						
22-0	14-11	254.7						

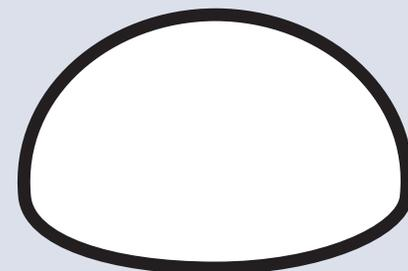

Notes for Aluminum Structural Plate HOC Tables:

1. Tables based upon AASHTO Sec. 12 Standard Specifications for Highway Bridges.
2. H-20, HS-20 Live Loads. (Contact TrueNorth Steel® for HL-93.)
3. Minimum cover is defined as the vertical distance from the top of the corrugated structure to the bottom of flexible or top of rigid pavement.
4. Minimum cover for off highway construction loads must be checked.
5. Minimum cover heights < span/8 determined by moment capacity analysis.
6. Greater cover heights possible with other plate thickness/rib combinations.
7. Arch footing reaction are available upon request.
8. TrueNorth Steel® can supply footing dimensions and design upon request.

Notes:

1. Tables based upon AASHTO Sec. 12 Standard Specifications for Highway Bridges.
2. H-20, HS-20 Live Loads (Contact your TrueNorth Steel® representative for HS-25, H-25 and HL-93 loading).
3. Minimum cover is defined as the vertical distance from the top of the corrugated structure to the bottom of flexible or top of rigid pavement.
4. Minimum cover for heavy off-road construction equipment loads must be checked.
5. Plate and rib combinations shown meet or exceed AASHTO Sec. 12.6 Standard Specifications for Highway Bridges.
6. Backfill in haunch area min. 4,000 psf bearing capacity.

TABLE 3-4. UNDERPASS STRUCTURES (H-20, HS-20 LIVE LOAD)

Metal Thickness (Inches) – Reinforcing Rib Type – Rib Spacing (Inches) (Maximum Cover – Ft.)								
Span Ft.-In.	Rise Ft.-In.	Approx. Area Sq. Ft.	Minimum Height-of-Cover (Feet)					
			1.25	1.50	2.00	2.50	3.00	3.50
6-1	5-9	28	.150	.125	.125	.125	.125	.125
6-3	6-1	30	(46)	(33)	(33)	(33)	(33)	(33)
6-3	6-6	32						
6-2	6-11	34						
6-4	7-3	37						
6-3	7-9	39						
6-5	8-1	42						
12-1	11-0	107.5		.125-II-9 (18)	.125-II-27 (18)	.125 (18)	.125 (18)	.125 (18)
12-10	11-2	116.6		.125-II-9 (17)	.125-II-27 (17)	.150 (17)	.125 (17)	.125 (17)
13-0	12-0	126.7						
13-8	12-4	136.7		.125-II-9 (16)	.125-II-18 (16)	.125-II-27 (16)	.125-II-54 (16)	.125-II-54 (16)
14-0	12-11	147.4						
14-6	13-5	156.7		.125-II-9 (16)	.125-II-18 (16)	.125-II-27 (16)	.125-II-54 (16)	.125-II-54 (16)
14-9	14-1	169.8						
15-5	14-5	179.2			.125-II-9 (15)	.125-II-27 (15)	.150-II-54 (15)	.150-II-54 (15)
15-7	15-2	193.6						
16-3	15-6	206.1			.150-II-9 (14)	.150-II-27 (14)	.150-II-27 (14)	.150-II-27 (14)
16-5	16-0	216.0						
16-8	16-4	222.3						
17-3	17-1	238.4			.150-II-18 (16)	.150-II-27 (16)	.150-II-27 (16)	.150-II-27 (16)
18-5	16-11	252.0						
19-0	17-3	266.0		.200-VI-9 (19)	.200-VI-18 (19)	.200-II-18 (19)	.200-II-27 (19)	.200-IV-27 (19)
19-7	17-7	280.2						
20-5	17-9	294.4						

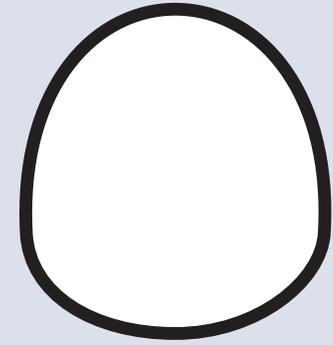

Note:

1. Maximum cover based on allowable corner bearing pressure of approximately 4,000 psf (2tsf).



Aluminum Structural Plate Box Culvert

Applications

Aluminum box culverts provide an excellent option for low-rise, wide-span box culvert or short span bridge requirements. These structures provide a wide, single opening with no obstructions to catch debris. They can be constructed on a full corrugated invert for erosion protection, corrugated footing pads or concrete footings. In many cases they can be fully assembled off site and lifted by a light crane or trackhoe and set in place. Consult with your TrueNorth Steel® representative when utilizing either the full invert option or corrugated footing pads. Sufficient bearing capacity is required for these options.

End Treatments

Aluminum box culverts may be constructed using a prefabricated corrugated aluminum headwall and wingwalls, cast-in-place concrete headwalls, segmental concrete block headwalls or the structure ends may be left projecting from the roadway embankment. TrueNorth Steel® advises that all culvert ends be sufficiently protected to preclude erosive and scouring forces that can damage the structure and the roadway embankment. Your TrueNorth Steel® representative is experienced with all of these end treatments and can provide details and guidance.

Reinforcing Ribs

These structures are comprised of a corrugated aluminum alloy shell and reinforcing ribs connected by 3/4" bolts to the side haunches and the crown. The height of cover tables on the following pages show the combinations of corrugated aluminum alloy shell thicknesses and reinforcing ribs to address different live load H and HS 20, H and HS 25 and HL 93. For designs with different live load conditions please contact your TrueNorth Steel® representative.

Refer to the Structure Selection examples which provide guidance on the usage the tables on the following pages.

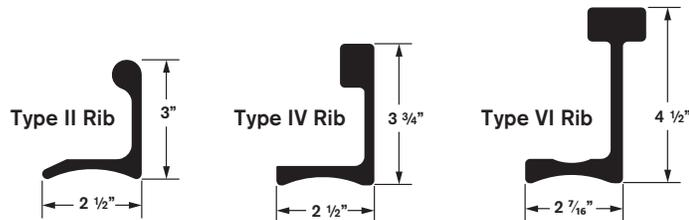

Reinforcing rib types and spacing are shown on the following tables as Type II, Type III and Type IV. The ribs used upon the haunch and the crown may be different types. The reinforcing rib spacing is shown on the following tables "Haunch Rib Spacing or HRS and Crown Rib Spacing or CRS.

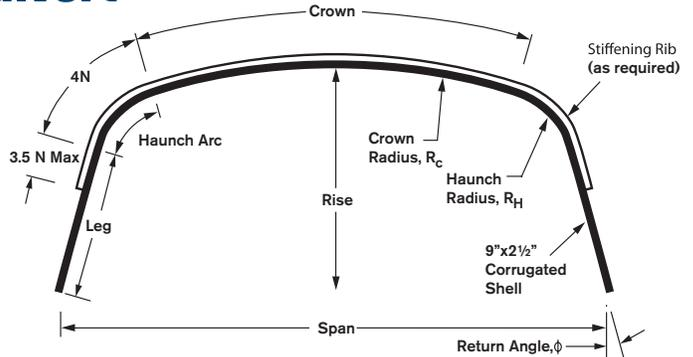

Haunch plate gage or HG as designated on the tables refers to the metal thickness. 2 = 0.125", 3 = 0.150", 4 = 0.175", 5 = 0.200", 6 = 0.225", 7 = 0.250.

Height of Cover Tables Measurement

The cover height shown on the Height of Cover Tables is measured from the top of the crown plates to the bottom of flexible pavement or to the top of rigid pavement.

Structure Selection Examples

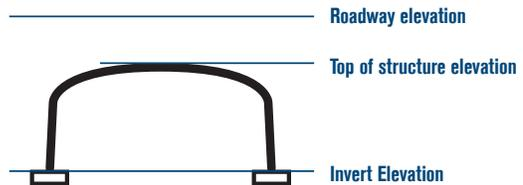

EXAMPLE 1

21' 3" span x 6' 10" rise structure

- a. 2.00' height of cover from top of structure to bottom of asphalt pavement
- b. AASHTO HS-20 live load
- c. Use Table 3-5 page 32 for HS-20

Result: Use Type 2 configuration with cover range 1.4' to 5.0'

EXAMPLE 2

6' 8" span x 7' 6" rise structure

- a. 4.00' height of cover from top of structure to bottom of asphalt pavement
- b. AASHTO HS-25 live load
- c. Use Table 3-6 page 33 for HS-25

Result: Use Type 2B configuration with cover range 2.7' to 5.0'

EXAMPLE 3

25' 4" span x 9' 5" rise structure

- a. 1.4' height of cover from the top of structure to bottom of asphalt pavement
- b. AASHTO HL-93 live load
- c. Use Table 3-7 page 34-35 for HL-93

Result: Use Type 3C configuration with cover range 1.4' to 5.0'



Corrugated footing pads



Aluminum headwall



Full corrugated invert



Aluminum headwall and wingwalls



Aluminum headwall

SuperSill™ Foundation Form

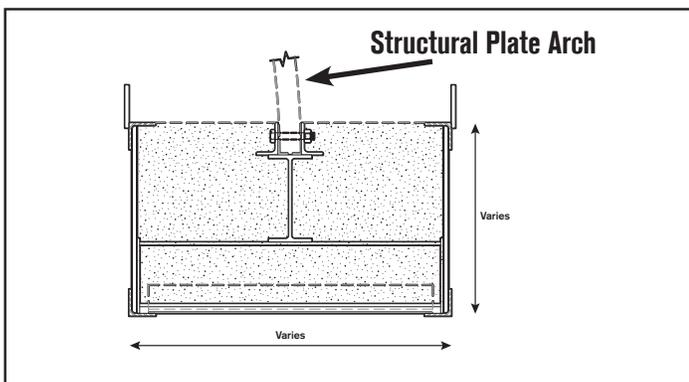

Placing SuperSill™ foundation forms

Box Culvert Structural Plate - Aluminum

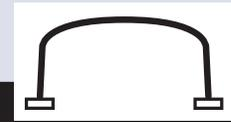

TABLE 3-5. SHELL DATA — H-20, HS-20 LOADING
PLATE AND RIB COMBINATIONS WITH ALLOWABLE HEIGHT OF COVER

Ref. Number	Span" Ft.-In.	Rise"B" Ft.-In.	Area Sq. Ft.	Type 1					Type 2					Type 3				
				HG/CG (Gage)	HRS/CRS (Inches)	Min. (Feet)	Max. (Feet)	Shell Wt./Ft. (Lbs.)	HG/CG (Gage)	HRS/CRS (Inches)	Min. (Feet)	Max. (Feet)	Shell Wt./Ft. (Lbs.)	HG/CG (Gage)	HRS/CRS (Inches)	Min. (Feet)	Max. (Feet)	Shell Wt./Ft. (Lbs.)
TYPE II HAUNCH AND TYPE IV CROWN RIBS																		
1	8-9	2-6	18.4	2/2	54/18	1.4	5.0	48										
2	9-2	3-3	25.4	2/2	54/18	1.4	5.0	53										
3	9-7	4-1	32.6	2/2	54/18	1.4	5.0	58										
4	10-0	4-10	40.2	2/2	54/18	1.4	5.0	61										
5	10-6	5-7	48.1	2/2	54/18	1.7	5.0	65	3/3	54/18	1.4	5.0	73					
6	10-11	6-4	56.4	2/2	54/18	2.0	5.0	69	2/2	27/18	1.4	5.0	77					
7	11-4	7-2	65.0	2/2	54/18	2.5	5.0	72	2/2	54/9	1.4	5.0	82					
8	10-2	2-8	23.0	2/2	54/18	1.7	5.0	56	3/3	54/18	1.4	5.0	62					
9	10-7	3-5	31.1	2/2	54/18	2.0	5.0	61	3/3	54/18	1.4	5.0	67					
10	10-11	4-3	39.5	2/2	54/18	2.0	5.0	65	3/3	54/18	1.4	5.0	72					
11	11-4	5-0	48.2	2/2	54/18	2.5	5.0	69	3/3	54/18	1.7	5.0	77	2/2	54/9	1.4	5.0	83
12	11-8	5-9	57.2	2/2	54/18	2.5	5.0	72	3/3	54/18	1.7	5.0	81	2/2	54/9	1.4	5.0	86
13	12-1	6-7	66.4	2/2	54/18	3.0	5.0	76	2/2	27/18	2.0	5.0	85	2/2	54/9	1.4	5.0	90
14	12-5	7-4	76.0	2/2	54/18	3.0	5.0	80	2/2	27/18	2.5	5.0	88	2/2	27/9	1.4	5.0	102
15	11-7	2-10	28.1	2/2	54/18	2.5	5.0	64	3/3	54/18	1.7	5.0	70	3/3	27/18	1.4	5.0	77
16	11-11	3-7	37.4	2/2	54/18	2.5	5.0	68	3/3	54/18	2.0	5.0	75	4/4	54/18	1.4	5.0	82
17	12-3	4-5	46.9	2/2	54/18	3.0	5.0	73	3/3	54/18	2.0	5.0	79	3/3	27/18	1.4	5.0	89
18	12-7	5-2	56.6	2/2	54/18	3.0	5.0	78	2/2	27/18	2.5	5.0	85	2/2	27/9	1.4	5.0	102
19	12-11	6-0	66.6	2/2	54/18	3.0	5.0	81	2/2	27/18	2.5	5.0	89	2/2	27/9	1.4	5.0	106
20	13-3	6-9	76.9	3/3	54/18	2.5	5.0	96	3/3	27/18	2.0	5.0	102	2/2	27/9	1.4	5.0	110
21	13-0	3-0	33.8	3/3	54/18	2.5	5.0	70	4/4	54/18	2.0	5.0	79	4/4	27/18	1.4	5.0	91
22	13-4	3-10	44.2	3/3	54/18	3.0	5.0	83	3/3	27/18	2.0	5.0	91	3/3	54/9	1.4	5.0	105
23	13-7	4-7	54.8	3/3	54/18	3.0	5.0	89	3/3	27/18	2.5	5.0	97	3/3	54/9	1.4	5.0	110
24	13-10	5-5	65.6	2/2	27/18	3.0	5.0	92	3/3	27/18	2.5	5.0	102	3/3	54/9	1.4	5.0	114
25	14-1	6-2	76.6	3/3	54/18	3.0	5.0	97	3/3	27/18	2.5	5.0	106	2/2	18/9	1.4	5.0	126
26	14-5	3-3	40.0	3/3	27/18	3.0	5.0	93	4/4	27/18	2.5	5.0	101	5/5	18/18	1.4	5.0	115
TYPE II HAUNCH AND TYPE VI CROWN RIBS																		
27	14-8	4-1	51.5	2/2	27/18	1.4	5.0	91										
28	14-10	4-10	63.2	2/2	27/18	1.4	5.0	106										
29	15-1	5-8	75.1	3/2	27/18	1.4	5.0	117										
30	15-4	6-5	87.2	3/2	27/18	1.4	5.0	121										
31	15-6	7-3	99.4	3/2	27/18	1.4	5.0	125										
32	15-9	8-0	111.8	2/2	27/18	2.0	5.0	121	3/2	18/18	1.4	5.0	136					
33	15-10	3-6	46.8	2/2	27/18	2.1	5.0	104	3/2	18/18	1.4	5.0	114					
34	16-0	4-3	59.5	2/2	27/18	2.3	5.0	110	3/2	18/18	1.4	5.0	121					
35	16-2	5-1	72.3	2/2	27/18	2.4	4.9	115	3/2	18/18	1.4	5.0	128					
36	16-4	5-11	85.2	2/2	27/18	2.6	4.5	119	3/2	18/18	1.4	5.0	133					
37	16-6	6-8	98.3	3/2	27/18	1.8	5.0	131	4/2	18/18	1.4	5.0	145					
38	16-8	7-6	111.5	3/2	27/18	1.9	5.0	135	4/2	18/18	1.4	5.0	150					
39	16-10	8-3	124.8	3/2	27/18	2.0	5.0	139	4/2	18/18	1.4	5.0	155					
ALL TYPE VI RIBS																		
40	17-9	3-10	54.4	2/2	54/18	2.0	5.0	112	2/2	27/18	1.4	5.0	124					
41	18-2	4-7	68.3	2/2	54/18	2.2	5.0	117	2/2	27/18	1.4	5.0	131					
42	18-7	5-4	82.5	2/2	54/18	2.4	5.0	123	2/2	27/18	1.4	5.0	139					
43	19-0	6-1	97.1	2/2	54/18	2.6	5.0	126	2/2	27/18	1.4	5.0	142					
44	19-5	6-11	111.9	2/2	54/18	2.8	5.0	130	2/2	18/18	1.4	5.0	159					
45	19-10	7-8	127.1	2/2	54/18	2.9	5.0	134	2/2	18/18	1.4	5.0	163					
46	20-3	8-5	142.6	2/2	27/18	1.9	5.0	137	2/2	18/18	1.4	5.0	166					
47	19-1	4-2	63.3	2/2	54/18	2.6	5.0	121	2/2	18/18	1.4	5.0	143					
48	19-5	4-11	78.3	2/2	54/18	2.8	5.0	126	2/2	18/18	1.4	5.0	152					
49	19-9	5-8	93.6	2/2	54/18	2.9	4.8	132	2/2	18/18	1.4	5.0	161					
50	20-1	6-6	109.2	2/2	27/18	1.9	5.0	151	2/2	18/18	1.4	5.0	165					
51	20-6	7-3	125.0	2/2	27/18	2.0	5.0	155	2/2	18/18	1.4	5.0	168					
52	20-10	8-1	141.2	2/2	27/18	2.1	5.0	159	2/2	18/18	1.4	5.0	172					
53	21-2	8-10	157.6	2/2	27/18	2.2	5.0	162	2/2	18/18	1.4	5.0	175					
54	20-4	4-6	73.1	2/2	27/18	2.0	5.0	142	2/2	18/18	1.4	5.0	152					
55	20-7	5-3	89.2	2/2	27/18	2.1	5.0	150	2/2	18/18	1.4	5.0	161					
56	20-11	6-1	105.5	2/2	27/18	2.2	5.0	157	2/2	18/18	1.4	5.0	170					
57	21-3	6-10	122.1	2/2	27/18	2.3	5.0	160	2/2	18/18	1.4	5.0	174					
58	21-6	7-8	139.0	2/2	27/18	2.3	5.0	164	2/2	18/18	1.4	5.0	177					
59	21-10	8-5	156.0	2/2	27/18	2.5	5.0	168	2/2	18/18	1.4	5.0	181					
60	22-1	9-3	173.3	2/2	27/18	2.5	4.8	171	2/3	18/18	1.4	5.0	189					
61	21-7	4-11	83.8	2/2	27/18	2.4	5.0	151	2/2	18/18	1.4	5.0	161					
62	21-10	5-8	101.0	2/2	27/18	2.5	5.0	159	2/2	18/18	1.4	5.0	170					
63	22-1	6-6	118.4	2/2	27/18	2.5	4.8	166	2/3	18/18	1.4	5.0	184					
64	22-3	7-3	135.9	2/2	27/18	2.6	4.6	169	2/3	18/18	1.4	5.0	188					
65	22-6	8-1	153.7	2/2	27/18	2.7	4.4	173	2/3	18/18	1.4	5.0	191					
66	22-9	8-10	171.6	2/2	27/18	2.8	4.2	177	2/4	18/18	1.4	5.0	195					
67	23-0	9-8	189.8	2/2	27/18	2.8	4.0	180	2/4	18/18	1.4	5.0	203					
68	22-9	5-4	95.5	2/2	27/18	2.8	4.2	160	2/4	18/18	1.4	5.0	180					
69	23-0	6-1	113.7	2/2	27/18	2.8	4.0	168	2/4	18/18	1.4	5.0	189					
70	23-2	6-11	132.1	3/3	27/18	2.6	4.4	188	2/5	18/18	1.4	5.0	203					
71	23-4	7-8	150.6	3/3	27/18	2.6	4.3	192	2/5	18/18	1.4	5.0	206					
72	23-6	8-																

Box Culvert Structural Plate – Aluminum



**TABLE 3-6. SHELL DATA — H-25, HS-25 LOADING
PLATE AND RIB COMBINATIONS WITH ALLOWABLE HEIGHT OF COVER**

Ref. Number	Span "A" Ft.-In.	Rise "B" Ft.-In.	Area Sq. Ft.	Type 1B					Type 2B					Type 3B				
				HG/CG (Gage)	HRS/CRS (Inches)	Min. (Feet)	Max. (Feet)	Shell Wt./Ft. (Lbs.)	HG/CG (Gage)	HRS/CRS (Inches)	Min. (Feet)	Max. (Feet)	Shell Wt./Ft. (Lbs.)	HG/CG (Gage)	HRS/CRS (Inches)	Min. (Feet)	Max. (Feet)	Shell Wt./Ft. (Lbs.)
TYPE II HAUNCH AND TYPE IV CROWN RIBS																		
1	8-9	2-6	18.4	2/2	54/18	1.7	5.0	48	3/3	54/18	1.4	5.0	53					
2	9-2	3-3	25.4	2/2	54/18	2.0	5.0	53	3/3	54/18	1.4	5.0	56					
3	9-7	4-1	32.6	2/2	54/18	2.0	5.0	58	3/3	54/18	1.4	5.0	60					
4	10-0	4-10	40.2	2/2	54/18	2.5	5.0	61	2/2	54/9	1.4	5.0	71					
5	10-6	5-7	48.1	2/2	54/18	2.5	5.0	65	2/2	54/9	1.4	5.0	75					
6	10-11	6-4	56.4	2/2	54/18	3.0	5.0	69	2/2	54/9	2.0	5.0	79	3/3	54/9	1.4	5.0	87
7	11-4	7-2	65.0	2/2	54/18	3.0	5.0	72	2/2	27/18	2.5	5.0	88	3/3	54/9	1.4	5.0	91
8	10-2	2-8	23.0	2/2	54/18	2.5	5.0	56	3/3	54/18	1.7	5.0	62	4/4	54/18	1.4	5.0	68
9	10-7	3-5	31.1	2/2	54/18	3.0	5.0	61	3/3	54/18	2.0	5.0	67	3/3	27/18	1.4	5.0	81
10	10-11	4-3	39.5	2/2	54/18	3.0	5.0	65	3/3	54/18	2.5	5.0	72	3/3	54/9	1.4	5.0	86
11	11-4	5-0	48.2	2/2	54/18	3.0	5.0	69	3/3	54/18	2.5	5.0	77	3/3	54/9	1.4	5.0	91
12	11-8	5-9	57.2	2/2	54/18	3.0	5.0	72	3/3	54/18	2.5	5.0	81	3/3	54/9	1.4	5.0	95
13	12-1	6-7	66.4	3/3	54/18	3.0	5.0	85	3/3	27/18	2.5	5.0	94	3/3	27/9	1.4	5.0	108
14	12-5	7-4	76.0	2/2	27/18	3.0	5.0	88	2/2	27/9	2.0	5.0	102	3/3	27/9	1.4	5.0	112
15	11-7	2-10	28.1	2/2	54/18	3.0	5.0	64	3/3	54/18	2.5	5.0	70	3/3	54/9	1.4	5.0	88
16	11-11	3-7	37.4	3/3	54/18	3.0	5.0	75	3/3	27/18	2.5	5.0	83	3/3	54/9	1.4	5.0	93
17	12-3	4-5	46.9	3/3	54/18	3.0	5.0	81	4/4	54/18	2.5	5.0	88	4/4	54/9	1.4	5.0	106
18	12-7	5-2	56.6	3/3	54/18	3.0	5.0	85	3/3	27/18	2.5	5.0	94	4/4	54/9	1.4	5.0	111
19	12-11	6-0	66.6	3/3	27/18	3.0	5.0	98	2/2	27/9	2.0	5.0	106	4/4	27/9	1.4	5.0	124
20	13-3	6-9	76.9	2/2	18/18	3.0	5.0	101	2/2	27/9	2.5	5.0	110	3/3	18/9	1.4	5.0	119
TYPE II HAUNCH AND TYPE VI CROWN RIBS																		
21	13-0	3-0	33.8	3/3	54/18	2.3	5.0	86	2/2	27/18	1.6	5.0	91	3/3	27/18	1.4	5.0	100
22	13-4	3-10	44.2	3/3	54/18	2.5	5.0	88	2/2	27/18	1.7	5.0	92	4/4	27/18	1.4	5.0	114
23	13-7	4-7	54.8	3/3	54/18	2.7	5.0	93	2/2	27/18	1.9	5.0	97	3/3	18/18	1.4	5.0	118
24	13-10	5-5	65.6	3/3	54/18	2.9	5.0	98	2/2	27/18	2.0	5.0	101	3/3	18/18	1.4	5.0	122
25	14-1	6-2	76.6	2/2	27/18	2.3	5.0	104	2/2	18/18	1.7	5.0	110	3/3	18/18	1.4	5.0	126
26	14-5	3-3	40.0	2/2	27/18	2.5	5.0	95	2/2	18/18	1.8	5.0	99	4/4	18/18	1.4	5.0	115
27	14-8	4-1	51.5	2/2	27/18	2.8	5.0	101	2/2	18/18	2.0	5.0	106	4/5	18/18	1.4	5.0	126
28	14-10	4-10	63.2	2/2	27/18	2.8	5.0	106	2/2	18/18	2.0	5.0	112	4/6	18/18	1.4	5.0	136
29	15-1	5-8	75.1	2/2	27/18	3.0	5.0	110	2/2	18/18	2.1	5.0	116	4/7	18/18	1.4	5.0	144
30	15-4	6-5	87.2	3/3	27/18	2.6	5.0	124	2/2	18/18	2.3	5.0	119	5/7	18/18	1.4	5.0	157
31	15-6	7-3	99.4	3/3	27/18	2.6	5.0	128	2/2	18/18	2.3	5.0	123	5/7	18/18	1.4	5.0	162
32	15-9	8-0	111.8	3/3	27/18	2.6	5.0	132	2/2	18/18	2.5	5.0	127	5/7	18/18	1.4	5.0	168
33	15-10	3-6	46.8	2/2	18/18	2.4	5.0	108	6/2	18/18	1.7	5.0	131	7/5	18/18	1.4	5.0	145
34	16-0	4-3	59.5	2/2	18/18	2.5	5.0	115	6/2	18/18	1.8	5.0	134	7/6	18/18	1.4	5.0	158
35	16-2	5-1	72.3	2/2	18/18	2.5	5.0	121	6/2	18/18	1.8	5.0	149	7/7	18/18	1.4	5.0	170
36	16-4	5-11	85.2	2/2	18/18	2.6	5.0	125	6/2	18/18	1.9	5.0	156	7/7	18/18	1.4	5.0	177
37	16-6	6-8	98.3	2/2	18/18	2.6	5.0	129	6/2	18/18	2.0	5.0	162	4/5	9/18	1.4	5.0	180
38	16-8	7-6	111.5	2/2	18/18	2.7	5.0	132	6/2	18/18	2.0	5.0	168	4/7	9/18	1.4	5.0	191
39	16-10	8-3	124.8	2/2	18/18	2.8	5.0	136	6/2	18/18	2.1	5.0	174	4/7	9/18	1.4	5.0	195
ALL TYPE VI RIBS																		
40	17-9	3-10	54.4	2/2	54/18	2.8	5.0	112	2/2	27/18	2.0	5.0	124	2/2	18/18	1.4	5.0	134
41	18-2	4-7	68.3	2/2	27/18	2.2	5.0	131	2/2	18/18	1.5	5.0	143	2/3	18/18	1.4	5.0	146
42	18-7	5-4	82.5	2/2	27/18	2.3	5.0	139	2/2	18/18	1.6	5.0	152	2/5	18/18	1.4	5.0	162
43	19-0	6-1	97.1	2/2	27/18	2.4	5.0	142	2/2	18/18	1.8	5.0	156	2/6	18/18	1.4	5.0	170
44	19-5	6-11	111.9	2/2	27/18	2.6	5.0	146	2/2	18/18	1.8	5.0	159	2/7	18/18	1.4	5.0	177
45	19-10	7-8	127.1	2/2	27/18	2.7	5.0	149	2/2	18/18	1.9	5.0	163	2/7	18/18	1.4	5.0	180
46	20-3	8-5	142.6	2/2	27/18	2.9	5.0	153	2/2	18/18	2.0	5.0	166	2/2	18/9	1.4	5.0	214
47	19-1	4-2	63.3	2/2	27/18	2.6	5.0	133	2/2	18/18	1.8	5.0	143	2/2	18/9	1.4	5.0	196
48	19-5	4-11	78.3	2/2	27/18	2.6	5.0	141	2/2	18/18	1.8	5.0	152	2/2	18/9	1.4	5.0	205
49	19-9	5-8	93.6	2/2	27/18	2.7	5.0	148	2/2	18/18	1.9	5.0	161	2/2	18/9	1.4	5.0	214
50	20-1	6-6	109.2	2/2	27/18	2.9	5.0	165	2/2	18/18	1.9	5.0	165	2/2	18/9	1.4	5.0	217
51	20-6	7-3	125.0	2/2	27/18	3.0	5.0	155	2/2	18/18	2.0	5.0	168	2/2	18/9	1.4	5.0	221
52	20-10	8-1	141.2	2/2	27/18	3.2	4.5	159	2/2	18/18	2.0	5.0	172	2/2	18/9	1.4	5.0	224
53	21-2	8-10	157.6	2/2	18/18	2.1	5.0	175	2/7	18/18	1.7	5.0	196	2/2	18/9	1.4	5.0	228
54	20-4	4-6	73.1	2/2	27/18	3.0	5.0	142	2/2	18/18	2.0	5.0	152	2/2	18/9	1.4	5.0	210
55	20-7	5-3	89.2	2/2	27/18	3.1	4.9	150	2/2	18/18	2.0	5.0	161	2/2	18/9	1.4	5.0	219
56	20-11	6-1	105.5	2/2	27/18	3.2	4.3	157	2/2	18/18	2.0	5.0	170	2/2	18/9	1.4	5.0	228
57	21-3	6-10	122.1	2/2	18/18	2.1	5.0	174	2/7	18/18	1.7	5.0	198	2/2	18/9	1.4	5.0	232
58	21-6	7-8	139.0	2/2	18/18	2.2	5.0	177	2/7	18/18	1.8	5.0	201	2/2	18/9	1.4	5.0	235
59	21-10	8-5	156.0	2/2	18/18	2.2	5.0	181	2/7	18/18	1.9	5.0	205	2/2	18/9	1.4	5.0	239
60	22-1	9-3	173.3	2/2	18/18	2.3	5.0	185	2/7	18/18	2.0	5.0	209	2/2	18/9	1.4	5.0	243
61	21-7	4-11	83.8	2/2	18/18	2.2	5.0	161	2/7	18/18	1.8	5.0	185	2/2	18/9	1.4	5.0	225
62	21-10	5-8	101.0	2/2	18/18	2.2	5.0	170	2/7	18/18	1.9	5.0	194	2/2	18/9	1.4	5.0	234
63	22-1	6-6	118.4	2/2	18/18	2.3	5.0	179	2/7	18/18	2.0	5.0	203	2/2	18/9	1.4	5.0	243
64	22-3	7-3	135.9	2/2	18/18	2.4	5.0	183	2/7	18/18	2.0	5.0	207	2/2	18/9	1.4	5.0	246
65	22-6	8-1	153.7	2/2	18/18	2.5	5.0	186	2/7	18/18	2.0	5.0	211	2/2	18/9	1.4	5.0	250
66	22-9	8-10	171.6	2/2	18/18	2.6	5.0	190	2/7	18/18	2.0	5.0	214	2/2	18/9	1.4	5.0	253
67	23-0	9-8	189.8	2/2	18/18	2.6	5.0	194	2/7	18/18	2.2	5.0	218	2/2	18/9	1.4	5.0	257
68	22-9	5-4	95.5	2/2	18/18	2.4	5.0	170	2/7	18/18	2.1	5.0	194	2/2	18/9	1.4	5.0	239
69	23-0	6-1	113.7	2/2	18/18	2.5	5.0	179	2/7	18/18	2.1	5.0	203	2/2	18/9	1.4	5.0	248
70	23-2	6-11	132.1	2/2	18/18	2.5	5.0	188	2/7	18/18	2.2	5.0	212	2/2	18/9	1.4	5.0	257
71	23-4	7-8	150.6	2/2	18/18	2.6	5.0	192	2/7	18/18	2.2	5.0	216	2/2	18/9	1.4	5.0	261
72	23-6	8-6	169.3	2/2	18/18	2.6	5.0	195	2/7	18/18	2.2	5.0	220	2/2	18/9	1.4	5.0	264
73	23-8	9-3	1															



**TABLE 3-7. SHELL DATA — LRFD HL-93
PLATE AND RIB COMBINATIONS WITH ALLOWABLE HEIGHT OF COVER**

Ref. Number	Span "A" Ft.-In.	Rise "B" Ft.-In.	Area Sq. Ft.	Type 1C					Type 2C					Type 3C				
				HG/CG (Gage)	HRS/CRS (Inches)	Min. (Feet)	Max. (Feet)	Shell Wt./Ft. (Lbs.)	HG/CG (Gage)	HRS/CRS (Inches)	Min. (Feet)	Max. (Feet)	Shell Wt./Ft. (Lbs.)	HG/CG (Gage)	HRS/CRS (Inches)	Min. (Feet)	Max. (Feet)	Shell Wt./Ft. (Lbs.)
TYPE II HAUNCH AND TYPE IV CROWN RIBS																		
1	8-9	2-6	18.4	2/2	54/18	1.4	5.0	43										
2	9-2	3-3	25.4	2/2	54/18	1.4	5.0	50										
3	9-7	4-1	32.6	2/2	54/18	1.5	5.0	58	2/2	27/18	1.4	5.0	67					
4	10-0	4-10	40.2	2/2	54/18	1.7	5.0	61	2/2	27/18	1.4	5.0	70					
5	10-6	5-7	48.1	2/2	54/18	2.1	5.0	66	2/2	27/18	1.6	5.0	74	2/2	18/18	1.4	5.0	83
6	10-11	6-4	56.4	2/2	54/18	2.3	5.0	69	2/2	27/18	1.8	5.0	77	2/2	27/9	1.4	5.0	88
7	11-4	7-2	65.0	2/2	54/18	2.6	5.0	73	2/2	27/18	2.1	5.0	81	2/2	27/9	1.4	5.0	91
8	10-2	2-8	23.0	2/2	54/18	1.9	5.0	57	2/2	27/18	1.4	5.0	63					
9	10-7	3-5	31.1	2/2	54/18	2.1	5.0	61	2/2	27/18	1.6	5.0	68	2/2	18/18	1.4	5.0	76
10	10-11	4-3	39.5	2/2	54/18	2.3	5.0	66	2/2	27/18	1.8	5.0	74	2/2	27/9	1.4	5.0	88
11	11-4	5-0	48.2	2/2	54/18	2.6	5.0	70	2/2	27/18	2.1	5.0	78	2/2	27/9	1.4	5.0	92
12	11-8	5-9	57.2	2/2	54/18	2.8	5.0	73	2/2	27/18	2.3	5.0	81	2/2	27/9	1.4	5.0	95
13	12-1	6-7	66.4	2/2	54/18	3.1	5.0	77	2/2	27/18	2.6	5.0	85	2/2	27/9	1.4	5.0	99
14	12-5	7-4	76.0	2/2	27/18	3.4	5.0	80	2/2	27/9	1.5	5.0	102	2/2	18/9	1.4	5.0	111
15	11-7	2-10	28.1	2/2	54/18	2.7	5.0	64	2/2	27/18	2.3	5.0	70	2/2	27/9	1.4	5.0	88
16	11-11	3-7	37.4	2/2	54/18	2.9	5.0	69	2/2	27/18	2.5	5.0	76	2/2	27/9	1.4	5.0	94
17	12-3	4-5	46.9	2/2	54/18	3.2	5.0	73	2/2	27/18	2.7	5.0	82	2/2	18/9	1.4	5.0	108
18	12-7	5-2	56.6	2/2	54/18	4.1	5.0	77	2/2	27/18	2.9	5.0	85	2/2	18/9	1.4	5.0	111
19	12-11	6-0	66.6	3/3	54/18	2.9	5.0	90	2/2	27/9	1.8	5.0	106	3/3	18/9	1.4	5.0	121
20	13-3	6-9	76.9	2/2	54/18	3.2	5.0	94	2/2	27/9	2.0	5.0	110	3/3	18/9	1.4	5.0	125
TYPE II HAUNCH AND TYPE VI CROWN RIBS																		
21	13-0	3-0	33.8	3/3	54/18	2.0	5.0	81	2/2	27/18	1.4	5.0	83					
22	13-4	3-10	44.2	3/3	54/18	2.4	5.0	82	2/2	27/18	1.5	5.0	85	2/2	18/18	1.4	5.0	97
23	13-7	4-7	54.8	3/3	54/18	2.6	5.0	88	2/2	27/18	1.6	5.0	89	2/2	18/18	1.4	5.0	103
24	13-10	5-5	65.6	3/3	54/18	2.9	5.0	90	2/2	27/18	1.8	5.0	92	3/3	18/18	1.4	5.0	116
25	14-1	6-2	76.6	3/3	54/18	3.2	3.7	95	2/2	27/18	2.1	5.0	96	3/3	18/18	1.4	5.0	120
26	14-5	3-3	40.0	4/4	54/18	2.6	5.0	99	3/3	27/18	1.7	5.0	103	3/3	18/9	1.4	5.0	140
27	14-8	4-1	51.5	2/2	27/18	2.7	5.0	100	3/2	27/18	1.9	5.0	106	3/2	18/9	1.4	5.0	149
28	14-10	4-10	63.2	2/2	27/18	2.8	5.0	106	3/2	27/18	2.0	5.0	107	3/2	18/9	1.4	5.0	156
29	15-1	5-8	75.1	2/2	27/18	3.1	3.8	110	2/2	18/18	2.1	5.0	117	3/2	18/9	1.4	5.0	160
30	15-4	6-5	87.2	3/2	27/18	2.2	5.0	119	3/2	18/18	2.0	5.0	128	3/2	18/9	1.4	5.0	164
31	15-6	7-3	99.4	3/2	27/18	2.3	5.0	125	3/2	18/18	2.1	5.0	132	3/2	18/9	1.4	5.0	168
32	15-9	8-0	111.8	3/2	27/18	2.4	5.0	129	3/2	18/18	2.2	5.0	136	3/2	18/9	1.4	5.0	173
33	15-10	3-6	46.8	2/2	18/18	2.4	5.0	109	3/2	18/18	2.2	5.0	114	3/2	18/9	1.4	5.0	156
34	16-0	4-3	59.5	2/2	18/18	2.5	5.0	116	3/2	18/18	2.3	5.0	121	3/2	18/9	1.4	5.0	163
35	16-2	5-1	72.3	2/2	18/18	2.6	5.0	122	3/2	18/18	2.4	5.0	128	3/2	18/9	1.4	5.0	166
36	16-4	5-11	85.2	3/2	27/18	2.9	5.0	126	3/3	18/18	2.4	5.0	136	3/2	18/9	1.4	5.0	175
37	16-6	6-8	98.3	2/2	18/18	2.9	5.0	129	3/3	18/18	2.5	5.0	141	3/2	18/9	1.4	5.0	179
38	16-8	7-6	111.5	3/2	18/18	2.6	5.0	143	3/2	18/9	1.6	5.0	183	4/2	18/9	1.4	5.0	192
39	16-10	8-3	124.8	3/2	18/18	2.7	5.0	156	3/2	18/9	1.8	5.0	187	4/2	18/9	1.4	5.0	193
ALL TYPE VI RIBS																		
40	17-9	3-10	54.4	2/2	54/18	3.2	5.0	114	2/2	27/18	2.2	5.0	124	2/2	27/9	1.4	5.0	181
41	18-2	4-7	68.3	3/2	54/18	3.3	5.0	125	2/2	27/18	2.4	5.0	131	2/2	27/9	1.4	5.0	191
42	18-7	5-4	82.5	2/2	27/18	2.6	5.0	139	2/2	18/18	1.9	5.0	153	2/2	18/9	1.4	5.0	200
43	19-0	6-1	97.1	2/2	27/18	2.8	5.0	142	2/2	18/18	2.0	5.0	156	2/2	18/9	1.4	5.0	203
44	19-5	6-11	111.9	2/2	27/18	3.0	5.0	146	2/2	18/18	2.1	5.0	160	2/2	18/9	1.4	5.0	207
45	19-10	7-8	127.1	2/2	27/18	3.5	4.5	149	2/2	18/18	2.2	5.0	164	2/2	18/9	1.4	5.0	210
46	20-3	8-5	142.6	3/3	27/18	3.5	3.9	166	2/2	18/18	2.4	5.0	167	2/2	18/9	1.4	5.0	214
47	19-1	4-2	63.3	2/2	27/18	2.9	5.0	133	2/2	18/18	2.0	5.0	144	2/2	18/9	1.4	5.0	194
48	19-5	4-11	78.3	2/2	27/18	3.0	5.0	140	2/2	18/18	2.1	5.0	153	2/2	18/9	1.4	5.0	203
49	19-9	5-8	93.6	2/2	27/18	3.4	4.8	148	2/2	18/18	2.2	5.0	162	2/2	18/9	1.4	5.0	211
50	20-1	6-6	109.2	3/2	27/18	3.5	3.9	159	2/2	18/18	2.3	5.0	165	2/2	18/9	1.4	5.0	218
51	20-6	7-3	125.0	4/3	27/18	3.4	4.6	166	2/2	18/18	2.5	5.0	168	2/2	18/9	1.4	5.0	222
52	20-10	8-1	141.2	5/3	27/18	3.3	4.7	170	2/2	18/18	2.6	5.0	172	2/2	18/9	1.4	5.0	225
53	21-2	8-10	157.6	2/2	18/18	2.7	5.0	175	5/4	18/18	2.4	5.0	214	2/2	18/9	1.4	5.0	229
54	20-4	4-6	73.1	2/2	18/18	2.4	5.0	152	5/4	18/18	2.2	5.0	180	2/2	18/9	1.4	5.0	211
55	20-7	5-3	89.2	2/2	18/18	2.5	5.0	161	5/5	18/18	2.2	5.0	195	2/2	18/9	1.4	5.0	220
56	20-11	6-1	105.5	2/2	18/18	2.6	5.0	170	5/5	18/18	2.3	5.0	206	2/2	18/9	1.4	5.0	229
57	21-3	6-10	122.1	2/2	18/18	2.7	5.0	174	5/5	18/18	2.4	5.0	212	2/2	18/9	1.4	5.0	233
58	21-6	7-8	139.0	2/2	18/18	2.8	5.0	178	2/2	18/9	1.5	5.0	235	3/3	18/9	1.4	5.0	249
59	21-10	8-5	156.0	2/2	18/18	3.0	5.0	182	2/2	18/9	1.6	5.0	239	3/3	18/9	1.4	5.0	253
60	22-1	9-3	173.3	2/2	18/18	3.1	4.8	185	2/2	18/9	1.7	5.0	243	3/3	18/9	1.4	5.0	257
61	21-7	4-11	83.8	2/2	18/18	2.9	5.0	162	2/2	18/9	1.5	5.0	225	3/3	18/9	1.4	5.0	236
62	21-10	5-8	101.0	2/2	18/18	3.0	5.0	171	2/2	18/9	1.6	5.0	234	3/3	18/9	1.4	5.0	246
63	22-1	6-6	118.4	2/2	18/18	3.1	4.8	180	2/2	18/9	1.7	5.0	243	3/3	18/9	1.4	5.0	256
64	22-3	7-3	135.9	2/2	18/18	3.2	4.4	184	2/2	18/9	1.7	5.0	246	4/4	18/9	1.4	5.0	273
65	22-6	8-1	153.7	3/2	18/18	3.2	4.2	196	2/2	18/9	1.8	5.0	250	4/4	18/9	1.4	5.0	278
66	22-9	8-10	171.6	2/3	9/18	2.8	5.0	249	2/2	18/9	1.8	5.0	253	4/4	18/9	1.4	5.0	283
67	23-0	9-8	189.8	2/3	9/18	2.9	5.0	253	2/2	18/9	1.9	5.0	257	4/4	18/9	1.4	5.0	288
68	22-9	5-4	95.5	2/3	9/18	2.8	5.0	219	2/2	18/9	1.8	5.0	239	4/4	18/9	1.4	5.0	263
69	23-0	6-1	113.7	2/3	9/18	2.9	5.0	233	2/2	18/9	1.9	5.0	248	4/4	18/9	1.4	5.0	274
70	23-2	6-11	132.1	2/3	9/18	2.9	5.0	248	2/2	18/9	2.0	5.0	266	5/5	18/9	1.4	5.0	297
71	23-4	7-8	150.6	2/3	9/18	3.0	5.0	251	2/2	18/9	2.0	5.0	270	5/5	18/9	1.4	5.0	303
72	23-6	8-6	169.3	2/3	9/18	3.0	5.0	255	2/2	18/9	2.0	5.0	274	5/5	18/9	1.4	5.0	308
73	23-8	9-3	188.1	2/3	9/18	3.1	5.0	258	2/2	18/9	2.1	5.0	278	5/5	18/9	1.4	5.0	314
74	23-10	10-1	207.0	2/3														



TABLE 3-7 (Continued). SHELL DATA – LRFD HL-93 PLATE AND RIB COMBINATIONS WITH ALLOWABLE HEIGHT OF COVER

Ref. Number	Span "A" Ft.-In.	Rise "B" Ft.-In.	Area Sq. Ft.	Type 1D					Type 2D					Type 3D				
				HG/CG (Gage)	HRS/CRS (Inches)	Min. (Feet)	Max. (Feet)	Shell Wt./Ft. (Lbs.)	HG/CG (Gage)	HRS/CRS (Inches)	Min. (Feet)	Max. (Feet)	Shell Wt./Ft. (Lbs.)	HG/CG (Gage)	HRS/CRS (Inches)	Min. (Feet)	Max. (Feet)	Shell Wt./Ft. (Lbs.)
88	26-7	5-5	111.6	3/3	9/18	4.0	5.0	246	3/3	9/9	2.3	5.0	314	3/4	9/9	2.0	5.0	320
89	27-0	6-3	132.4	3/3	9/18	4.0	5.0	261	3/3	9/9	2.3	5.0	329	3/4	9/9	2.0	5.0	335
90	27-5	7-0	153.4	3/3	9/18	4.0	5.0	276	3/3	9/9	2.3	5.0	344	3/4	9/9	2.0	5.0	350
91	27-10	7-9	174.8	3/3	9/18	4.0	5.0	292	3/3	9/9	2.3	5.0	360	3/4	9/9	2.0	5.0	366
92	28-3	8-7	196.5	3/3	9/18	4.0	5.0	296	3/3	9/9	2.3	5.0	364	3/4	9/9	2.0	5.0	370
93	28-8	9-4	218.6	3/3	9/18	4.0	5.0	300	3/3	9/9	2.3	5.0	368	3/4	9/9	2.0	5.0	374
94	29-2	10-1	241.0	3/3	9/18	4.0	5.0	304	3/3	9/9	2.3	5.0	372	3/5	9/9	2.0	5.0	383
95	27-10	5-10	125.4	3/3	9/18	4.0	5.0	261	3/3	9/9	2.3	5.0	329	3/4	9/9	2.0	5.0	335
96	28-3	6-8	147.3	3/3	9/18	4.0	5.0	276	3/3	9/9	2.3	5.0	344	3/4	9/9	2.0	5.0	350
97	28-7	7-5	169.4	3/3	9/18	4.0	5.0	292	3/3	9/9	2.3	5.0	360	3/4	9/9	2.0	5.0	366
98	29-0	8-3	191.8	3/3	9/18	4.0	5.0	307	3/3	9/9	2.3	5.0	375	3/5	9/9	2.0	5.0	386
99	29-4	9-0	214.6	3/3	9/18	4.0	5.0	311	3/3	9/9	2.3	5.0	379	3/5	9/9	2.0	5.0	390
100	29-8	9-9	237.6	3/3	9/18	4.0	5.0	315	3/3	9/9	2.3	5.0	383	3/5	9/9	2.0	5.0	394
101	30-1	10-7	260.9	3/3	9/18	4.0	5.0	319	3/3	9/9	2.4	5.0	387	3/5	9/9	2.0	5.0	398
102	29-1	6-4	140.2	3/3	9/18	4.0	5.0	276	3/3	9/9	2.3	5.0	344	3/5	9/9	2.0	5.0	357
103	29-5	7-1	163.2	3/3	9/18	4.0	5.0	292	3/3	9/9	2.3	5.0	360	3/5	9/9	2.0	5.0	373
104	29-8	7-11	186.4	3/3	9/18	4.0	5.0	307	3/3	9/9	2.3	5.0	375	3/5	9/9	2.0	5.0	388
105	30-0	8-8	209.8	3/3	9/18	4.0	5.0	322	3/3	9/9	2.4	5.0	390	3/5	9/9	2.0	5.0	403
106	30-4	9-5	233.6	3/3	9/18	4.0	5.0	326	3/3	9/9	2.4	5.0	394	3/5	9/9	2.0	5.0	407
107	30-8	10-3	257.5	3/3	9/18	4.0	5.0	330	3/3	9/9	2.4	5.0	398	3/5	9/9	2.0	5.0	411
108	31-0	11-0	281.8	3/3	9/18	4.0	5.0	335	3/3	9/9	2.4	5.0	403	3/5	9/9	2.0	5.0	416
109	30-3	6-9	156.1	3/3	9/18	4.0	5.0	287	3/3	9/9	2.5	5.0	360	3/5	9/9	2.0	5.0	373
110	30-6	7-7	180.1	3/3	9/18	4.0	5.0	302	3/3	9/9	2.4	5.0	375	3/5	9/9	2.0	5.0	388
111	30-10	8-4	204.4	3/3	9/18	4.0	5.0	317	3/3	9/9	2.4	5.0	390	3/5	9/9	2.0	5.0	403
112	31-1	9-2	228.8	3/3	9/18	4.0	5.0	332	3/3	9/9	2.4	5.0	405	3/5	9/9	2.0	5.0	418
113	31-4	9-11	253.5	4/3	9/18	4.0	5.0	346	3/3	9/9	2.5	5.0	409	3/5	9/9	2.0	5.0	422
114	31-8	10-9	278.4	4/3	9/18	4.0	5.0	351	3/3	9/9	2.5	5.0	414	3/5	9/9	2.0	5.0	427
115	31-11	11-6	303.5	4/3	9/18	4.0	5.0	356	3/3	9/9	2.5	5.0	418	3/5	9/9	2.0	5.0	431
116	31-5	7-3	173.1	4/3	9/18	4.0	5.0	304	3/3	9/9	2.5	5.0	375	3/5	9/9	2.0	5.0	388
117	31-8	8-0	198.2	4/3	9/18	4.0	5.0	320	3/3	9/9	2.5	5.0	390	3/5	9/9	2.0	5.0	403
118	31-10	8-10	223.4	4/3	9/18	4.0	5.0	336	3/3	9/9	2.5	5.0	405	3/5	9/9	2.0	5.0	418
119	32-1	9-8	248.8	4/3	9/18	4.0	5.0	352	3/3	9/9	2.5	5.0	420	3/5	9/9	2.0	5.0	433
120	32-3	10-5	274.4	4/3	9/18	4.0	5.0	357	3/3	9/9	2.5	5.0	424	3/5	9/9	2.0	5.0	437
121	32-7	11-3	300.1	4/3	9/18	4.0	5.0	362	3/3	9/9	2.5	5.0	429	3/5	9/9	2.0	5.0	442
122	32-8	12-0	326.1	4/3	9/18	4.0	5.0	367	3/3	9/9	2.5	5.0	433	3/5	9/9	2.0	5.0	446
123	32-7	7-9	191.3	4/3	9/18	4.0	5.0	314	3/3	9/9	2.5	5.0	390	3/5	9/9	2.0	5.0	403
124	32-9	8-6	217.3	4/3	9/18	4.0	5.0	330	3/3	9/9	2.5	5.0	405	3/5	9/9	2.0	5.0	418
125	32-11	9-4	243.4	4/3	9/18	4.0	5.0	346	3/3	9/9	2.5	5.0	420	3/5	9/9	2.0	5.0	433
126	33-1	10-2	269.7	4/3	9/18	4.0	5.0	362	3/3	9/9	2.5	5.0	435	3/5	9/9	2.0	5.0	448
127	33-3	10-11	296.4	4/3	9/18	4.0	5.0	367	3/3	9/9	2.5	5.0	440	3/6	9/9	2.0	5.0	454
128	33-5	11-9	322.8	4/3	9/18	4.0	5.0	372	3/3	9/9	2.5	5.0	444	3/6	9/9	2.0	5.0	466
129	33-8	12-6	349.5	4/3	9/18	4.0	5.0	376	3/3	9/9	2.5	5.0	448	3/6	9/9	2.0	5.0	470
130	33-8	8-3	210.5	4/3	9/18	4.0	5.0	325	3/3	9/9	2.5	5.0	405	3/6	9/9	2.0	5.0	427
131	33-9	9-1	237.5	4/3	9/18	4.0	5.0	340	3/3	9/9	2.5	5.0	420	3/6	9/9	2.0	5.0	442
132	33-11	9-10	264.5	4/3	9/18	4.0	5.0	356	3/3	9/9	2.5	5.0	435	3/6	9/9	2.0	5.0	457
133	34-0	10-8	291.7	4/3	9/18	4.0	5.0	372	3/3	9/9	2.5	5.0	451	3/6	9/9	2.0	5.0	473
134	34-2	11-5	319.0	4/3	9/18	4.0	5.0	377	3/3	9/9	2.5	5.0	455	3/6	9/9	2.0	5.0	477
135	34-3	12-3	346.4	4/3	9/18	4.0	5.0	382	3/3	9/9	2.5	5.0	459	3/6	9/9	2.0	5.0	481
136	34-5	13-1	373.8	4/3	9/18	4.0	5.0	387	3/3	9/9	2.5	5.0	463	3/6	9/9	2.0	5.0	485
137	34-9	8-9	230.9	4/3	9/18	4.0	5.0	335	3/3	9/9	2.5	5.0	420	3/6	9/9	2.0	5.0	442
138	34-10	9-7	258.1	4/3	9/18	4.0	5.0	351	3/3	9/9	2.5	5.0	435	3/6	9/9	2.0	5.0	457
139	34-11	10-4	286.7	4/3	9/18	4.0	5.0	367	3/3	9/9	2.5	5.0	451	3/6	9/9	2.0	5.0	473
140	35-0	11-2	314.6	4/3	9/18	4.0	5.0	382	3/3	9/9	2.5	5.0	466	3/6	9/9	2.0	5.0	488
141	35-1	12-0	342.7	4/3	9/18	4.0	5.0	387	3/3	9/9	2.5	5.0	470	3/6	9/9	2.0	5.0	492
142	35-2	12-9	370.8	4/3	9/18	4.0	5.0	392	3/3	9/9	2.5	5.0	474	3/6	9/9	2.0	5.0	496
143	35-3	13-7	399.0	4/3	9/18	4.0	5.0	394	3/3	9/9	2.5	5.0	476	3/6	9/9	2.0	5.0	500

See #3 in Structure Selection Examples on page 30

TruePlate™ Structural Plate

Sizes, Shapes and Height of Cover Tables

GALVANIZED STEEL AND ALUMINUM ALLOY



Local Ownership. Local Production.
Since 1945



TrueNorth Steel®

TrueNorthSteel.com
info@TrueNorthSteel.com | 866-982-9511



STRUCTURAL



TANKS



CORRUGATED
PIPE



BRIDGES



LOGISTICS



SALS3027_SH_06-17