

## INTRODUCTION

This chapter presents information of fundamental importance regarding installation and construction procedures including base preparation, unloading, assembly, and placement and compaction of the backfill (see Figure 10.1). Procedures for both shop fabricated cor-



■ **Figure 10.1** Proper compaction equipment close to structure.

rugated steel pipe and field assembled structural plate structures are provided. The emphasis is on corrugated steel pipe in installations such as highway culverts and storm drain pipe. For additional information, reference may also be made to the NCSA “Installation Manual” (Figure 10.2), and to ASTM recommended practices A 796 / A 796 M, A 798 / A 798 M, and A 807 / A 807 M. The National Corrugated Steel Pipe Association’s member manufacturers are also an excellent source for local installation requirements and recommendations.

A well situated, properly bedded, correctly assembled, and carefully backfilled steel drainage structure will function properly and efficiently over its design life. Although smaller structures and structures with low cover may demand less care in installation than larger ones, reasonable precautions in handling, base preparation, assembly and backfilling are required for pipes of any material.



Corrugated steel structures, because of their strength, light weight and resistance to fracture, can be installed quickly, easily and with the least expensive equipment. The flexible steel shell is designed to distribute external loads to the backfill around it and function as a soil-steel structure interaction system as shown in Figure 10.3. Such flexibility permits unequaled tolerance to settlement and dimensional changes that would cause failure in rigid structures and other types of flexible pipe. This clear advantage of corrugated steel structures is further strengthened when they are installed on a well prepared foundation, and surrounded by a well compacted backfill of stable material. Reasonable care during installation is required. Just as with drainage structures of concrete or other materials, careless installation of corrugated steel structures can undo the work of the designer.

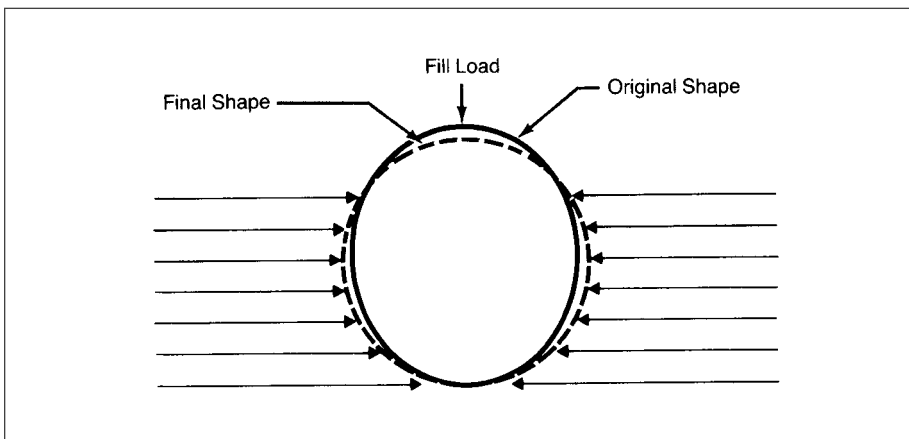

■ **Figure 10.3** Corrugated steel pipe functions structurally as a flexible ring that is supported by and interacts with the compacted surrounding soil. The soil constructed around the pipe is thus an integral part of the structural system. Therefore it is important to ensure that the soil structure or backfill is made up of acceptable material and that it is well-constructed.

In Chapter 7, Structural Design, minimum cover requirements were presented for corrugated steel pipe under highway and railway loadings. These requirements are based on years of practical experience, as well as fundamental design criteria. However, it must be emphasized that such minimum covers may not be adequate during the construction phase, because of the higher live loads incurred. Therefore, when construction equipment that produces wheel loads or gross loads greater than those for which the pipe has been designed, is to be driven over or close to the structure, it is the responsibility of the contractor to provide any additional cover needed to avoid damage to the pipe. More information regarding construction load requirements is found under the headings, *Important Considerations During Compaction*, found later in this chapter.

## BASE PREPARATION

### Foundation

Pressure developed by the weight of the backfill and live loads is transmitted both to the side fill and the strata underlying the pipe. The supporting soil beneath the pipe, generally referred to as the foundation (Figure 10.4), must provide both longitudinal and lateral support.

A properly developed foundation will:

- Maintain the conduit on a uniform grade.
- Aid in maintaining desired cross-sectional shape.
- Allow for uniform distribution of loading without developing stress concentrations in the pipe wall.



■ **Figure 10.4** A properly developed foundation is important.

### Preliminary Foundation Considerations

#### Soft Foundation

Evaluation of the construction site may require subsurface exploration to detect undesirable foundation material, such as soft material (muck) or rock ledges. Zones of soft material give uneven support and can cause the pipe to shift and settle non-uniformly after the pipeline is constructed. Materials with poor or non-uniform bearing capacity should be removed and replaced with suitable compacted fill to provide a continuous foundation that uniformly supports the imposed pressures. The bedding may then be prepared as for normal foundations. Figure 10.5 illustrates the treatment of soft foundations.

It is important that poor foundation material be removed for a suitable distance on either side of the pipe and replaced with compacted backfill. Otherwise, that material will settle under the load of the backfill alone and actually increase the load on the pipe. This is referred to as “dragdown soil loading”.

Reference the Structural Design Chapter for further information regarding the treatment of soft foundations.

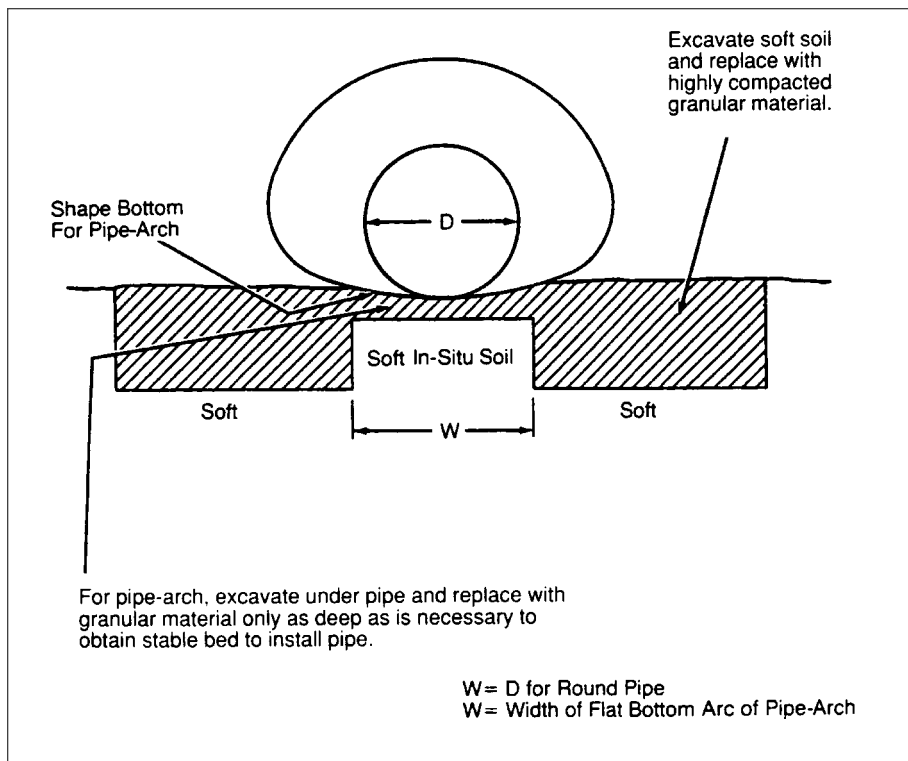

■ **Figure 10.5** Soft foundation treatment.

### Rock Foundations

If rock ledges are encountered in the foundation, they may serve as hard points that tend to concentrate the loads on the pipe. Such load concentrations are undesirable because they can lead to distortion of the structure. Thus large rocks or ledges must be removed and replaced with suitable compacted fill before preparing the pipe bedding. Furthermore, when the pipe foundation makes a transition from rock to compressible soil, special care must be taken to provide for reasonably uniform longitudinal support. Figure 10.6 illustrates the treatment for rock foundations and transition zones.

### Bedding Foundation

The portion of the foundation in contact with the bottom of the structure is referred to as the bedding. Depending upon the size and type of structure, the bedding may either be flat or shaped. Good bedding foundations can be viewed as a “cushion” for the conduit and should be relatively yielding when compared with compacted material placed between the trench wall or embankment and the pipe. In this manner, a soil arch can develop over the pipe, thus reducing the load transmitted to the conduit.

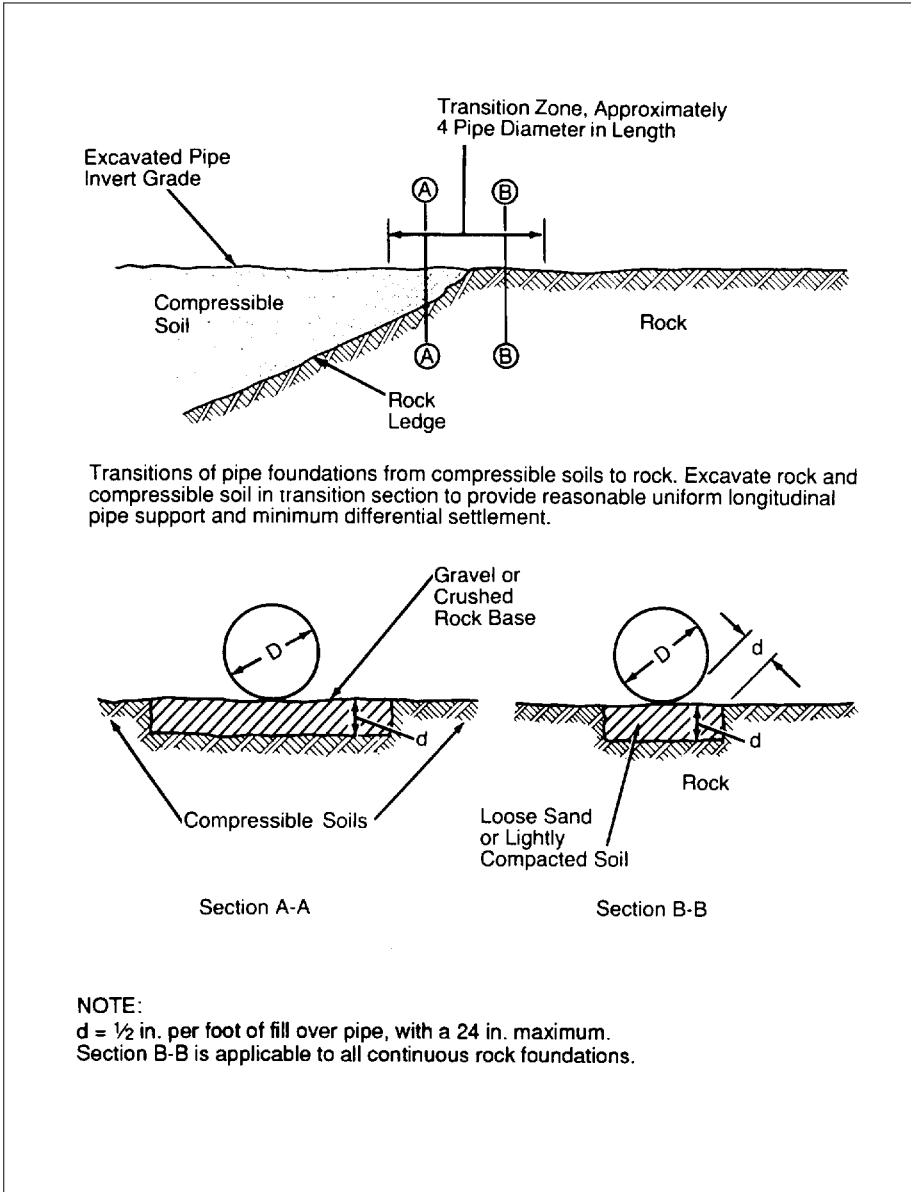

■ **Figure 10.6** Rock foundations and transition zones.

### Normal Round Pipe Bedding

With flat bedding (Figure 10.7), which is typical for factory-made round pipe, the pipe is placed directly on the fine-graded upper portion of the foundation. Soil must then be compacted under the haunches of the structure in the first stages of backfill.

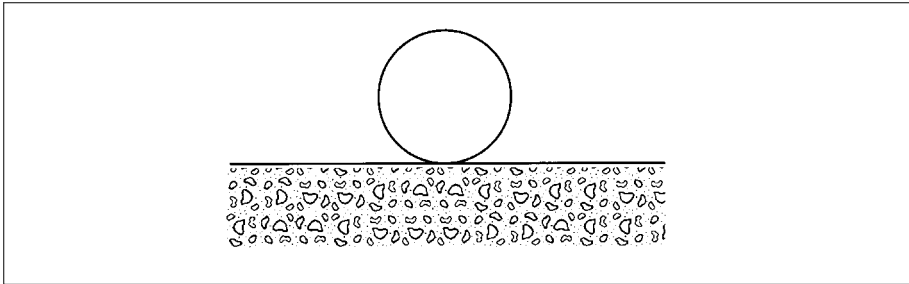

■ **Figure 10.7** Pipe placed on flat bedding.

The upper 2 to 6 inch layer should be relatively loose material to allow the corrugations to seat in the bedding. The material in contact with the pipe should not contain gravel larger than 3 inches, frozen lumps, chunks of highly plastic clay, organic matter, or other deleterious material. Figure 10.8 shows bedding for parallel runs of pipe.



■ **Figure 10.8** Proper bedding is important for multiple barrel installations.

## Special Bedding Considerations

### Pipe Arch and Large Diameter Pipe

The bedding concept for pipe arch structures also relates to large diameter and underpass shapes. For these structures, the bedding should be shaped to the approximate contour of the bottom portion of the structure. Alternatively, the bedding can be graded to a

slight V-shape. Shaping the bedding affords a more uniform support for the relatively flat bottom of these structures. The shaped portion need not extend across the entire bottom, but must be wide enough to permit the efficient compaction of the backfill under the remaining haunches of the structure.

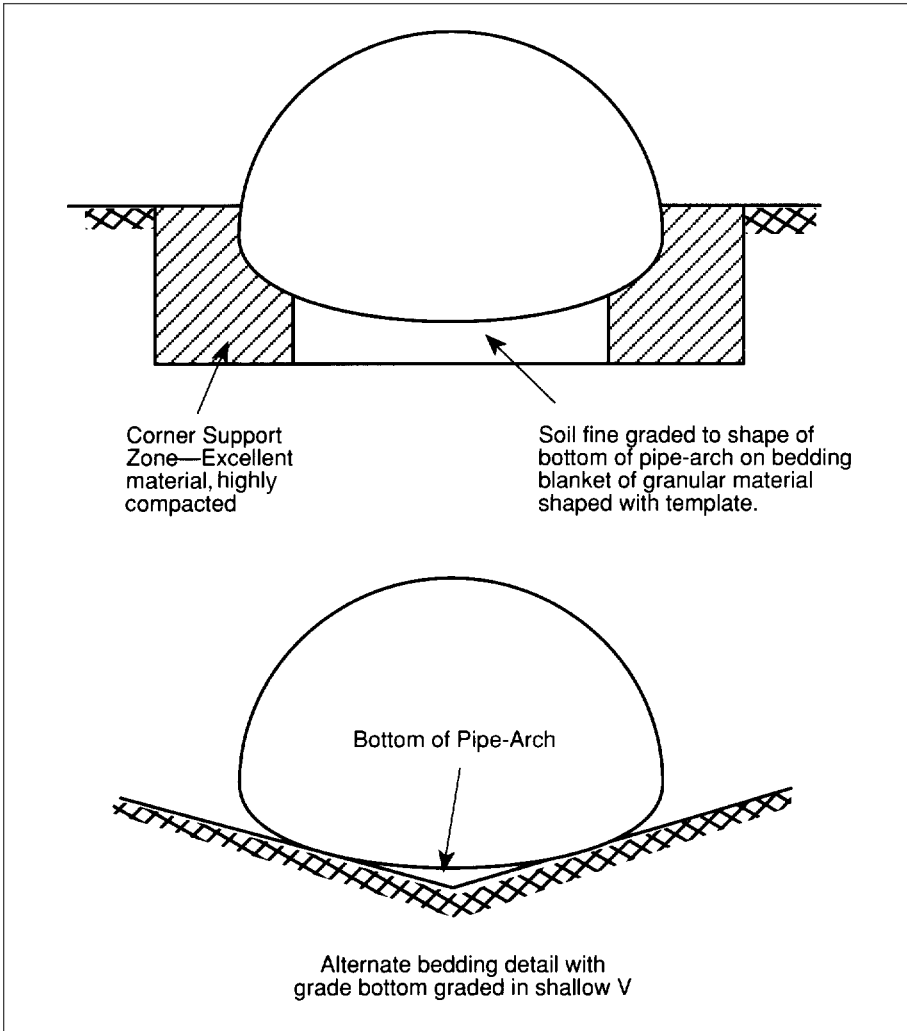

■ **Figure 10.9** Shaped bedding for pipe arch and large diameter structures.

Figure 10.9 illustrates shaped bedding for a pipe arch. Note that the soil beside and below the corners of a pipe arch must be of excellent quality, highly compacted, and thick enough to spread and accommodate the high reaction pressures that can develop at those locations. It is important in pipe arch installation to ensure a favorable relative movement of the haunches with respect to the pipe bottom. For this reason, a slightly yielding foun-

ation under the bottom, as compared to the haunches, is desirable. This factor is illustrated in Figure 10.10.

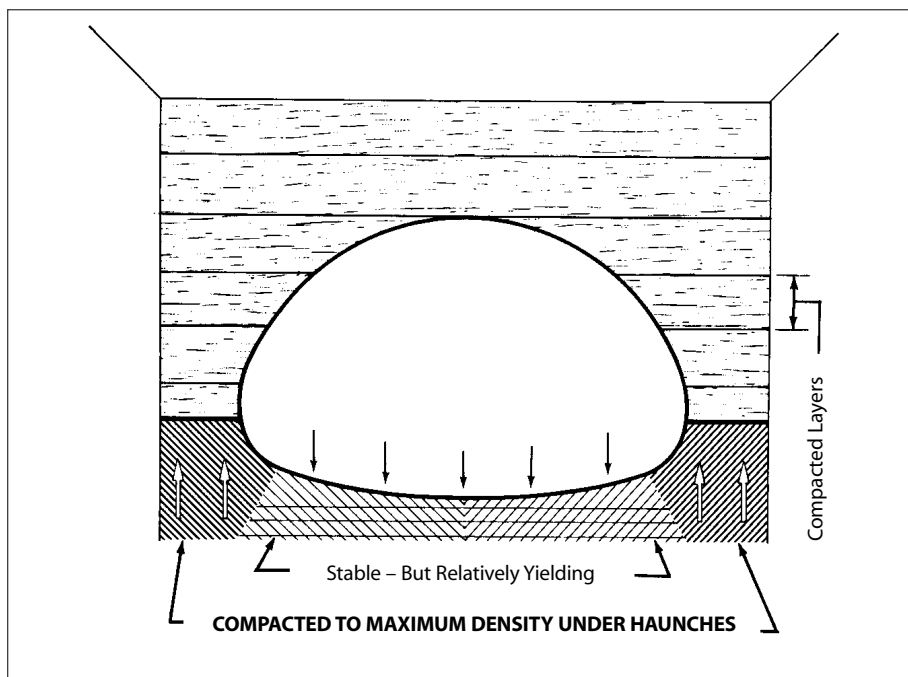

■ **Figure 10.10** Pipe arch loads are carried at the corners. Arrows show the direction of favorable relative motion of all pipe arches.

### Submerged Bedding

Preferably, the bedding and backfill operation should be conducted entirely in the dry. In rare cases, however, the installation of corrugated steel pipe may have to be done "in-the-wet". For sites where it is not possible or practical to divert the stream, it is common practice to pre-assemble and lift, roll, or skid CSP or Structural Plate Pipe into place. Since such conditions make it very difficult to ensure good base preparation and proper backfill compaction, the designer should consider quality granular backfill materials that achieve the required strength when dumped into standing water. Expert advice is recommended.

### Camber

For embankment installations, camber in the grade under high fills, or on a foundation that may settle, should be considered in base preparation. Camber is simply an increase in the foundation or bedding elevation at the center of a culvert above a straight line connecting its ends (the intended grade or slope of the pipe). The objective is to shape and/or elevate the grade to assure a proper flow line after settlement takes place. This



forethought will prevent sag in the middle of the culvert that might pocket water, or reduce hydraulic capacity because of sedimentation. Generally, enough camber can be obtained by placing the base for the upstream half of the pipe on an almost flat grade, and the downstream half on a steeper than normal grade. The greater load at the center of the embankment and the corresponding settlement will result in the desired positive slope after full consolidation. Soils engineering techniques are available to predict the amount of camber required for unusual conditions. It is possible to obtain a camber in the structure equal to one-half of one percent of its length without special fittings. For structures under high fills, the ordinates of the camber curve should be determined by a soils engineer. Figure 10.11 illustrates camber for a pipe under a high fill.

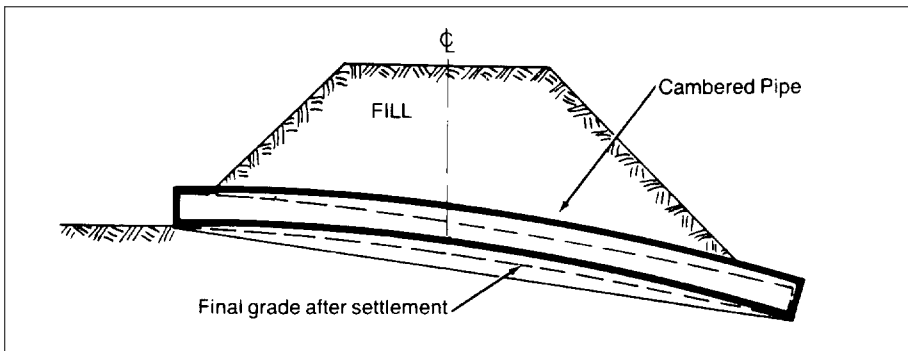

■ **Figure 10.11** Camber allows for settlement of a culvert under a high fill. Most of the fall is in the outlet half. Diameters 10 feet and smaller are easier to camber, as are the lighter wall thicknesses.

## INSTALLATION OF CORRUGATED STEEL PIPE AND PIPE ARCH

### Unloading and Handling

Although corrugated steel drainage structures will withstand rough handling without deformation, they should be handled with reasonable care. Pipe should never be dumped directly from a truck bed while unloading, but should be lifted or rolled to protect the coated surface. Dragging the structures at any time may damage the coatings and jeopardize durability. Also, avoid striking rocks or hard objects when lowering pipe into trenches.

Corrugated steel structures are relatively light in weight and can be handled with simple, light equipment. If necessary, a small crew can lower pipe into trenches by means of rope slings. Where the pipe is to be set in a trench, it is necessary to have equipment with a large enough reach to allow proper rigging of the lifting straps, cables, etc. as seen in Figure 10.12.



■ **Figure 10.12** Lifting CSP into place.

## Lifting Lug Locations

The recommended technique for lifting sections of pipe is the use of slings whenever possible. In situations where the use of slings is not possible, lifting lugs can be used. Figure 10.12a shows a diagram of the recommended lifting lug location for pipe loads up to 4,000 lbs utilizing 2 lugs. Figure 10.12b covers 4 lugs and loads up to 8,000 lbs.



■ **Figure 10.12a** Lifting lugs for pipes to 4000 lb.



■ **Figure 10.12b** Lifting lugs for pipes to 8000 lb.

### Assembly

#### Coupling

The usual method of joining two or more lengths of pipe or pipe arch is by means of steel connection bands. The bands engage the ends of each pipe section and are placed to overlap an equal length of each pipe providing an integral and continuous structure. During the construction of a corrugated steel pipe system, care should be given to the treatment of joints to prevent both infiltration and exfiltration. Both processes will have an adverse effect upon backfill materials, since soil particle migration can occur. This is particularly true when fine-grained soils (silt and clay) are present in the backfill material. The addition of a geosynthetic wrap or gasket material around the pipe joint can provide additional soil tightness to the coupling system. See Figure 10.13 below.



■ **Figure 10.13** CSP pipe joints wrapped with geosynthetic wrap.

Performance requirements are published in Division II, Section 26.4.2, of the current edition of the AASHTO Bridge Specifications. The AASHTO Specifications provide an excellent description of the different joint types and properties. Joint properties include shear strength, moment strength, tensile ( pull-apart ) strength, joint overlap, soil tightness and water tightness. Their recommended minimum requirements depend on whether the pipe is being installed in erodible or non-erodible soil. It should be emphasized that most corrugated steel pipe installations will only require a standard joint.

### Typical Corrugated Steel Pipe Band Installation

One-piece bands are used on small diameter pipe. Two or three-piece bands are used on larger diameter pipe (see Figure 10.14) and when installation conditions are difficult. Rod and lug bands are used on levees, aerial sewers and similar installations where improved water-tightness (or beam strength) is essential. Bands utilizing gaskets are commonly used in restricted leakage applications. Specially fabricated connectors can be supplied for use in jacking and for special or unusual conditions.



■ **Figure 10.14** Pre-fabricated miter section of CSP is lowered into place to match bend in trench.

Bands are put into position at the end of one section of pipe with the band open to receive the next section, depending on the type of band, the second section is brought against or to within about 1 inch of the first section as seen in Figure 10.15. After checking to see that connecting parts of both band and pipe section match, and that the interior of bands and exterior of pipe are clean, bolts are inserted and tightened.

To speed the coupling operation, especially for large diameter structures, a chain or cable-cinching tool will help tighten the band. Special clamping tools are available that fit over coupling band connectors and quickly draw the band together. Such devices permit faster hand tightening of the bolts, so that a wrench is required only for final tightening.

On large diameter structures, merely tightening the bolts will not assure a tight joint because of the friction between the band and the pipe ends. In such installations, tap the band with a rubber mallet to cause it to move relative to the pipe as the band is tightened. The wrench used to tighten coupling bands can be a box end wrench, but greater assem-



■ **Figure 10.15** Band used to join reformed end helical pipe.

bly speed can be accomplished with a speed wrench or ratchet wrench equipped with a deep socket.

More information is available on the different band types and assembly instructions in the NCSA “Installation Manual”.

### **Coated Pipe Band Installation**

On coated pipe, the surface between coupler and pipe may need lubrication with vegetable oil or a soap solution. This will allow the band to slip around the pipe more easily and to draw it into place more firmly, particularly in cold weather. Lubricating and tapping the band, with a rubber mallet, as it is tightened will help ensure a good joint. Where damage to the coating exposes the metal, repair by patching should be done before the structure is backfilled. A suitable repair material is asphalt mastic.

### **Paved Invert Pipe Band Installation**

Pipe with bituminous pavement must be installed with the smooth, thick pavement in the bottom. To simplify such placement and to speed handling, paved invert pipe lengths may be ordered with metal tabs or lifting lugs fastened to the pipe exterior exactly opposite the location of the pavement. Slings, with lifting hooks inserted in the lugs, automatically locate the paved invert in the bottom of the structure. Band installation is similar to that described above.

### Pre-Fabricated Pipe Fittings and Field Adjustments

#### Manholes

Shop fabricated corrugated steel manholes are available for all shapes of corrugated steel pipe structures. They are designed to receive standard cast iron appurtenances such as manhole covers and grates. Corrugated steel manholes have the advantage of quick installation and backfilling, thus reducing the possibility of damage to the pipeline due to flooding caused by unexpected weather conditions. Installation of a manhole riser is seen in Figure 10.16.

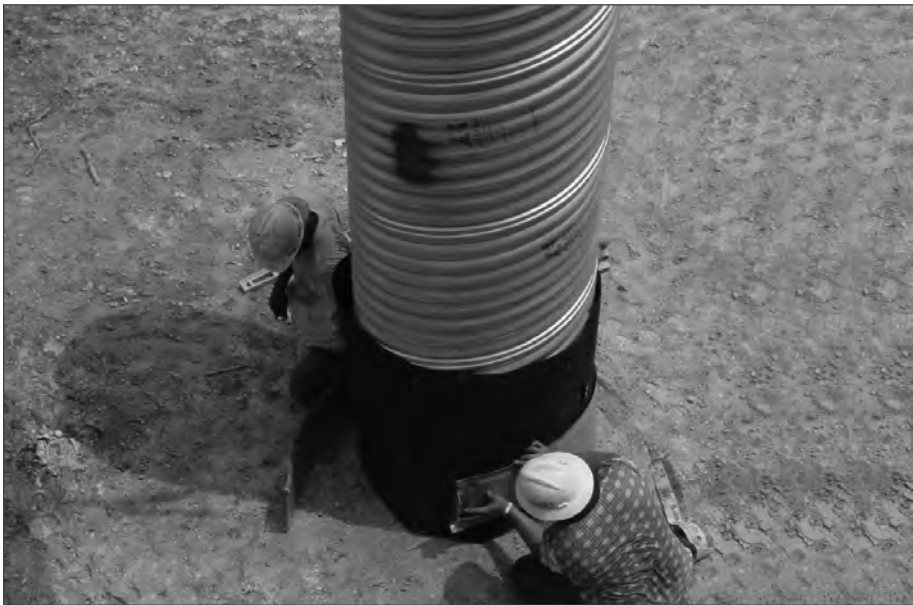

■ **Figure 10.16** CSP manhole being installed.

Manholes are multipurpose in function. They provide access for maintenance, serve as junction chambers where several conduits are joined together, provide an inlet for storm water from a grate inlet and are used to facilitate a change in horizontal or vertical alignment.

Monolithic concrete junction chambers are usually square or rectangular in shape. Structures of this design have the distinct disadvantage of causing turbulent flow conditions that, in effect, reduce the carrying capacity in upstream portions of the conduit system.

It is frequently desirable to change the horizontal or vertical alignment of large diameter corrugated steel drainage structures without the use of a manhole or junction chamber.

Shop fabricated elbow sections are available for this purpose and, in most instances; the additional fabrication cost is more than offset by eliminating the manhole or junction chamber. Manhole design is discussed in Chapter 8.

### Elbows, Tees and Wyes

Elbow pipe sections can be prepared to provide gradual changes in flow direction. Such fittings are prepared from standard pipe, pipe arch or arch sections and have the advantage of providing a change in direction without interrupting the flowline. Figure 10.17 graphically indicates the form of these sections that are available in any increment between  $0^\circ$  and  $90^\circ$ . Elbow fittings can be used in conjunction with each other, thus providing a custom design to accommodate required field conditions. For example, a horizontal alignment change of  $90^\circ$  could be negotiated through the use of three  $30^\circ$  or four  $22\ 1/2^\circ$  sections. A horizontal shift in alignment can easily be accommodated by the use of two elbow fittings, with the second fitting simply installed in reverse orientation to the first.

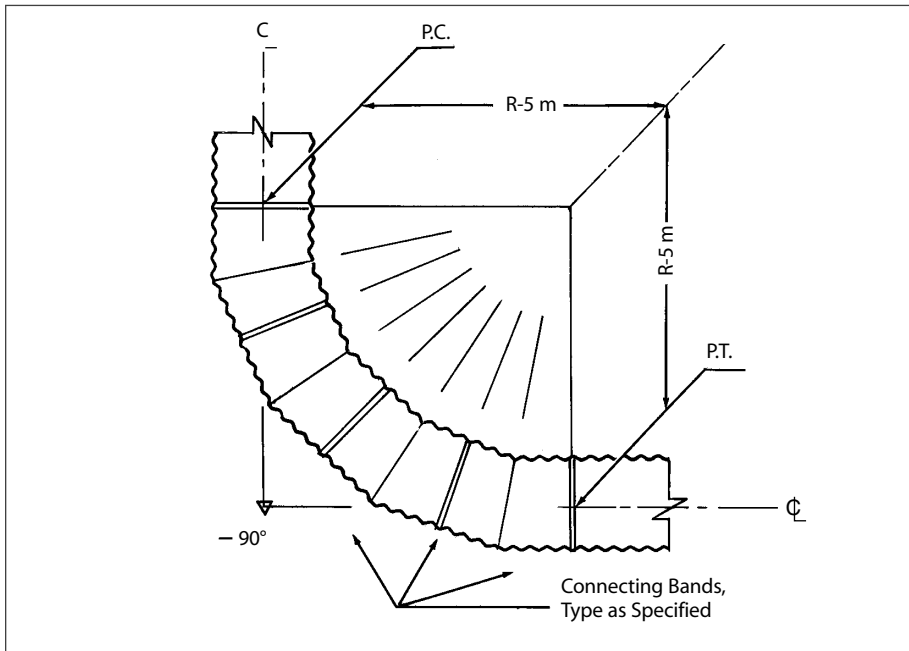

■ **Figure 10.17** Alignment for pipe elbow sections. The above is a design to negotiate a  $90^\circ$  alignment change through the use of four  $22\ 1/2^\circ$  sections.

The use of special fittings and elbow sections requires precise surveys both in the design and layout stages. The accurate location of special items must be predetermined in order for the manufacturer to supply fittings and straight pipe sections that will conform to field conditions. Layout and installation must be done with care to ensure proper positioning of all portions of the corrugated steel pipe system. The field layout procedure for

elbow pipe sections involves geometry similar to that of a standard highway curve. It should be noted, however, that only the center points at the end of each elbow section lie on the path of the circular curve.

### Saddle Fittings

Saddle fittings are available to aid the connection of laterals or other branches entering or leaving the main structure. Figure 10.18 demonstrates an example of a saddle fitting. They are especially useful where the exact location or grade of existing tie-ins are unknown prior to construction. While the longitudinal location of a saddle fitting must be spaced to the pitch of the corrugation, any line at any angle may be joined to the main or line simply by cutting or sawing the required hole. The saddle branch is attached over this opening and the incoming line is then attached to the fitting.



■ **Figure 10.18** Typical CSP saddle fitting.

## PLACEMENT AND COMPACTION OF BACKFILL

### Selection of Structural Backfill

The Structural Design Chapter details the importance of backfill selection, specifically pertaining to requirements for large diameter pipes and higher heights of cover, reference to that chapter should be made for those situations.



For the roadway conduit to support the pavement or track above it adequately and uniformly, a stable composite structure is vital. Stability in a soil-steel structure interaction system requires not only adequate design of the structure barrel, but also a well-engineered backfill. Performance of the flexible conduit in retaining its shape and structural integrity depends greatly on the selection, placement and compaction of the envelope of earth surrounding the structure, which distributes its pressures to the surrounding soil masses.

Requirements for selecting and placing backfill material around or near the conduit are similar, in some respects, to those for a roadway embankment. However, a difference in requirements arises because the conduit may generate more lateral pressure than would the earth within the embankment if no structure existed. Therefore, the soil adjacent to the conduit must be well compacted. Standard compaction specifications call for achieving a minimum of 90% standard proctor density (per AASHTO T-99).

### **Soil Design for CSP**

Highway and railroad engineering departments have detailed specifications for selecting and placing material in embankments. These specifications provide for wide variations in terrain and for available local materials. They can generally apply to backfill material around conduits for normal installations. If abnormal conditions exist at a specific site or if unusual performance is expected of a conduit and embankment, a soils engineer should be consulted for designing the backfill.

Backfill material should preferably be granular to provide good structural performance and ease of compaction. Bank, pit run gravel, or coarse sands are usually satisfactory. Very fine granular backfill material may infiltrate into the structure and should be avoided, particularly when a high ground water table is anticipated. When a coarse granular backfill is placed next to a fine native or embankment material, the soils must be separated by a suitable transition soil or filter fabric to control migration into the backfill. Where infiltration is desirable to lower the ground water table, geotextiles are also used to provide the necessary separation function.

### **Cohesive Backfill**

Often, the backfill material may be selected from the available materials at hand. Highly plastic or organic soils are unsuitable. However, materials with some degree of plasticity (SM GM, etc.) can be used in most instances. The stiffness of corrugated steel pipe allows these materials to be placed and compacted to the density necessary to support the pipe. For hydraulic structures, if the backfill trench wall or embankment materials contain fine sands or silts, an appropriately graded backfill material is necessary to control soil migration or piping. Alternatively, soil migration can be controlled by using a geotextile fabric as a separator.

The height of final soil cover, as well as the stiffness of the pipe itself, dictate which materials are suitable. The soil load that must be carried by the pipe often depends upon the quality (stiffness) of the backfill. Higher covers dictate better backfill materials that not only reduce the loads on the pipe, but also provide better support and improved structural strength. If cohesive backfill material is to be used, geotechnical advice is recommended.

### Hydraulic Backfill

Cement slurries, or other materials that set up without compaction, may be practical for unusual field conditions. Limited trench widths or relining of existing structures may warrant the use of self-setting cementitious slurries or grout. Care must be taken to ensure that all voids are filled, and that the material used will provide the compressive strength required. As with water consolidation techniques, measures should be taken to prevent floatation. Some techniques are covered in this chapter under the heading, *floatation*, but, expert advice is recommended.

## Backfill and Compaction Density

Experience and research have shown the critical density of backfill to be below 85% Standard Proctor Density. Backfill must be compacted to a greater density than critical to assure good performance. Therefore, backfill for all structures should be compacted to a specified 90% minimum per AASHTO T-99 or greater if required by manufacturers specifications.

## Compaction Equipment

### Hand Equipment

For compaction under the haunches of a structure, a pole (or 2 by 4 inch), timber, or air tamper is generally needed to work in the smaller areas. Hand tampers for compacting horizontal layers should not weigh less than 20 lbs. and have a tamping face not larger than 6 by 6 inches. Tampers typically used for sidewalk construction are generally too light.

### Mechanical Compactors

Most types of power tampers are satisfactory and can be used in all but the most confined areas. However, they must be used carefully and completely over the entire area of each layer to obtain the desired compaction. Care should be exercised to avoid striking the structure with power tamping tools.

### Rollers

Where space permits, walk-behind, small riding or rubber-tired rollers, as well as other types of tamping rollers, can be used to compact backfill around the structure. If rollers

are used, fill adjacent to the structure should be tamped with hand-held power equipment. Be sure to keep the rollers from hitting the structure. Generally, sheep-foot rollers are used for compacting only clay backfill or embankment material.

### Vibrating Compactors

Vibrating equipment is excellent for compaction of granular backfills, but generally is unsatisfactory for clay or other plastic soils.

### Flooding and Jetting

Flooding or jetting backfill for consolidation is only effective where the foundation material is able to take the water out of the backfill quickly. The rapid movement of the water carrying the finer backfill material down into the lower levels of the backfill achieves consolidation. Only clean, well graded sand and gravels can be consolidated by this means.

## Placing Backfill Around the Structure

Fill material under haunches and around the structure should be placed in loose layers 6 to 12 inches thick, depending on the quality of the backfill material, to permit thorough compaction. The backfill shall be placed and compacted with care under the haunches of the pipe and shall be raised evenly on both sides of the pipe by working backfill oper-

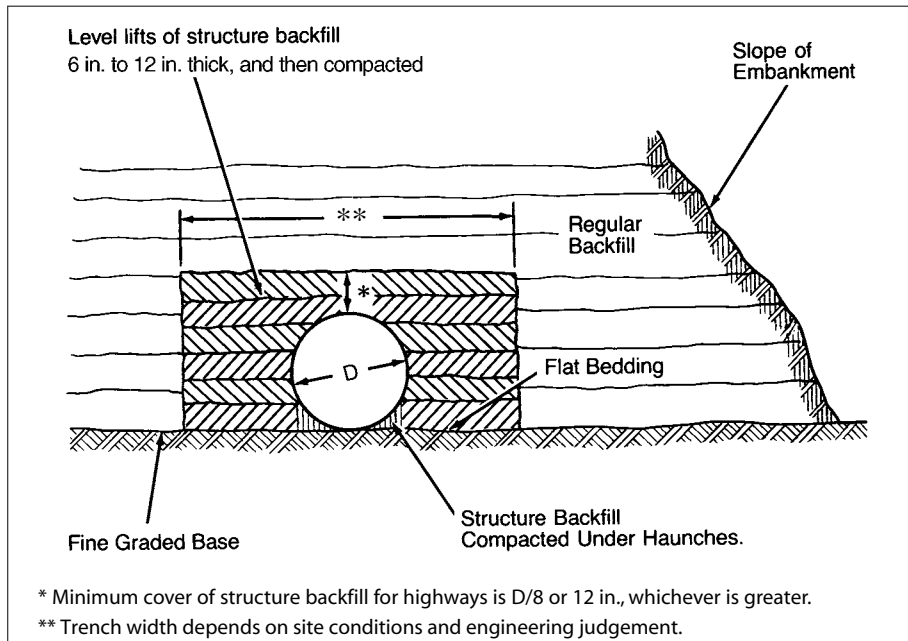

■ **Figure 10.19** Typical backfill envelope for round pipe installed on flat bedding, in an embankment condition.

ations from side to side. The side to side backfill differential shall not exceed 24 inches or one-third of the rise of the structure, whichever is less. Figures 10.19 and 10.20 show how round and pipe arch structures should be backfilled. Pipe arches require that the backfill at the corners (sides) be of the best material, and be especially well compacted.

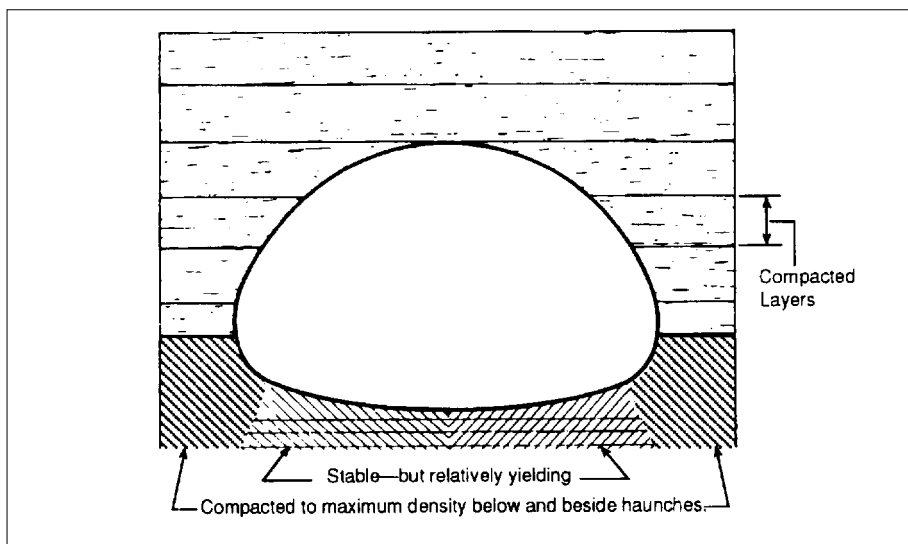

■ **Figure 10.20** Compaction below and beside the haunches of pipe arches is important.

Compaction can be done with hand or mechanical equipment, tamping rollers, or vibrating compactors, depending upon the type of soil and field conditions. Placing the fill material carefully, controlling its moisture content and the lift thickness, will allow for easier compaction of the fill and speed construction.

### Steps in Backfill Operation

Backfilling and compacting under the haunches are important steps in the backfill sequence. The material under the haunches must be in firm contact with the entire bottom surface of the structure. The area under the pipe haunches is more difficult to fill and compact and sometimes does not receive adequate attention. Care must be taken to assure that voids and soft spots do not occur under the haunches. Manual placement and compaction must be used to build up the backfill in this area.

Windrow backfill material on each side of the structure and place it under haunches by shovel. Compact firmly by hand with 2 by 4 inch tampers, or suitable power compactors (Figure 10.21). Continue placing backfill equally on each side, in uncompacted layers from 8 to 12 inches in depth, depending on the type of material and compaction equipment or methods used. Each layer must be compacted to the specified density before adding the next. These compacted layers must extend to the trench wall or to compacted embankment material.

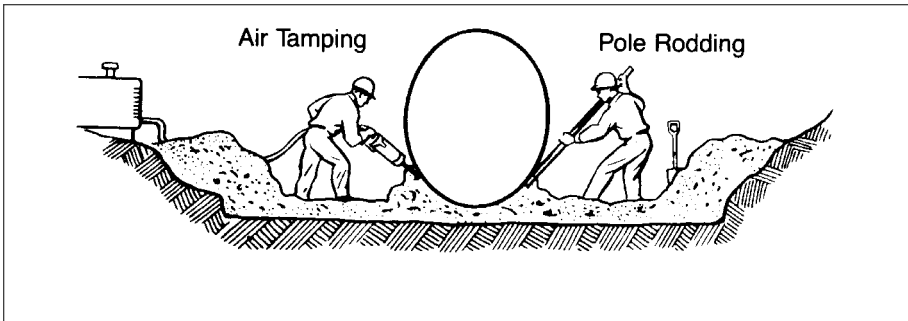

■ **Figure 10.21** Backfill under the haunches should be placed and compacted by the most economical methods available, consistent with providing uniform compaction without soft spots.

Backfill in the corrugation valleys and the area immediately next to the pipe should be compacted by hand-operated methods (Figure 10.22). Heavy compaction equipment may approach as close as 3 to 6 feet, depending on the size of the structure. Any change in dimension or plumb of the structure warns that heavy machines must work further away.



■ **Figure 10.22** Proper use of Compaction Equipment.

Structural backfill should be compactible soil or granular fill material. Structural backfill may be excavated native material, when suitable. Select materials (not larger than 3 in.), with excellent structural characteristics, are preferred. Desired end results can be obtained

with such material with less compaction effort over a wide range of moisture contents, lift thicknesses, and compaction equipment. To ensure that no pockets of uncompacted backfill are left next to the structure and to minimize the impact of material placement and compaction methods, follow this simple rule:

**All equipment runs parallel to the length of the pipe (Figure 10.23) until such time as the elevation of the backfill reaches a point that is at least  $3/4$  of the rise of the structure.**

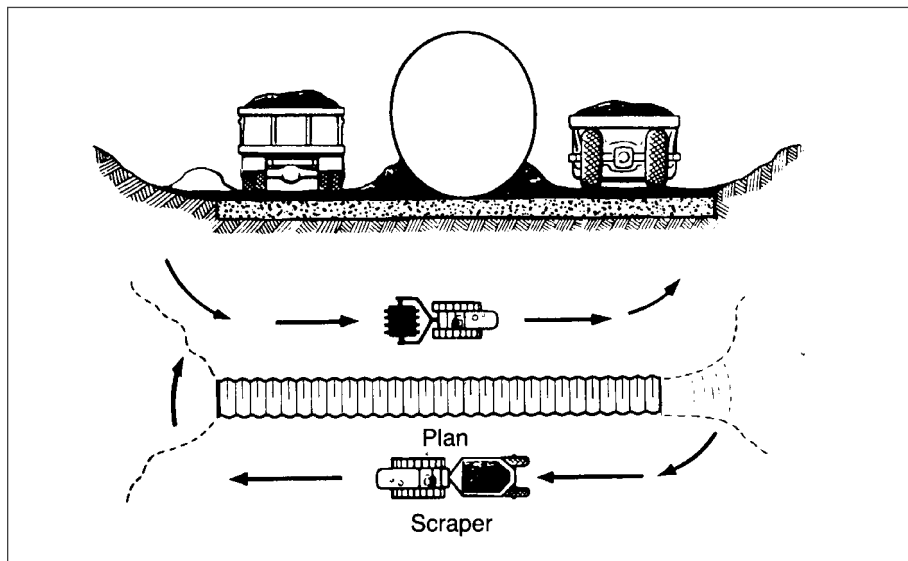

■ **Figure 10.23** Good backfilling practice.

Figure 10.24 illustrates poor practices. The possibility of uncompacted fill, or voids next to the structure are bound to arise with equipment operating at right angles to the structure. Mounding and dumping of backfill material against the structure will also adversely effect the installation.

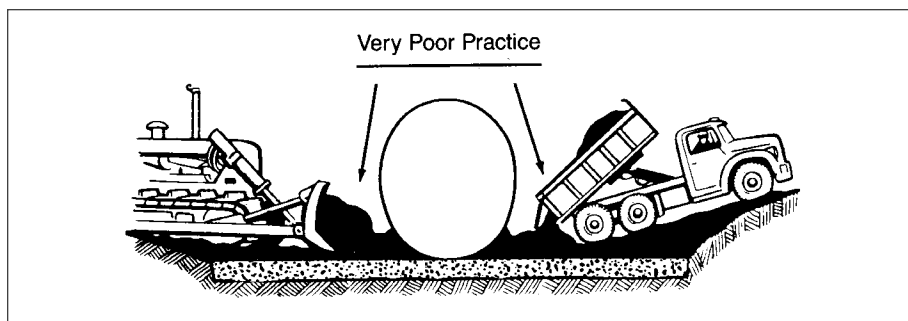

■ **Figure 10.24** Poor backfilling practice.

A balanced sequence of backfilling on either side is recommended:

### **For embankment installations**

- Dump trucks or scrapers windrow granular backfill one-half to one span away (depending on size of structure and site) on either side.
- Graders or dozers spread in shallow lifts for compaction.

### **For trench installations**

Backfill is placed with a loader or stone bucket to a depth to not exceed 3 feet or one third the rise, whichever is less, and then spread to the lift thickness.

### **For all installations**

- Pedestrian-type compactors are used for close work, while heavier self-propelled vibratory drum compactors are used away from the structure and for the rest of the soil envelope, once minimum cover is achieved.
- Supervision of material placement and compaction methods and inspection of pipe shape provide invaluable feedback.
- Hand work, or very light equipment, is used over the top of the structure until minimum cover is achieved.
- Monitor the shape of the structure during backfill. A slight peaking (increase in rise) indicates compaction is being achieved. Pushing it out of plumb means heavy equipment is working too close or the backfill is being placed from one side.

## **Drainage and Hydraulic Protection During Backfill Operation**

During installation (prior to the completion of backfilling, permanent end treatment, slope protection and flow controls) the structure is vulnerable to storm and flow conditions that may be less than the final design levels. Hydraulic flow forces on unprotected ends, unbalanced backfill loads, loss of backfill and support due to erosion and flotation uplift forces, are examples of factors to be considered. While guidance is offered in some of the above sections, temporary protection may be necessary during construction.

Hydraulic forces can float incomplete structures without protection or buckle inverts if the foundation, bedding or backfill becomes inundated. Large radius inverts are especially vulnerable to buckling. If flow is channeled through a structure that is being installed, placing end treatments and slope protection as early as possible are advised. Temporary clay dikes can direct the water flow into the pipe. Protect structures that have coffer dams. Protect trench installations from surface runoff and ponding. Storm sewers and other pipes with inlets need to have branches properly connected so flow is into the main line, not the trench.

In order to provide proper drainage of the backfill above the spring line, it is desirable to grade or slope the fill slightly toward the ends of the structure (where headwalls are not present). This also facilitates fill over the crown, or locking-in the structure. Conversely,

if headwalls are built prior to backfilling, work should proceed from the ends towards the middle. Both of these approaches are shown in Figure 10.25. The headwall first approach is useful where it is desirable to divert the stream through the structure and/or to give cut and fill access to both sides at an early stage. Care must be exercised to provide for surface runoff, to prevent ponding or saturation of the backfill from rainfall or snowmelt.

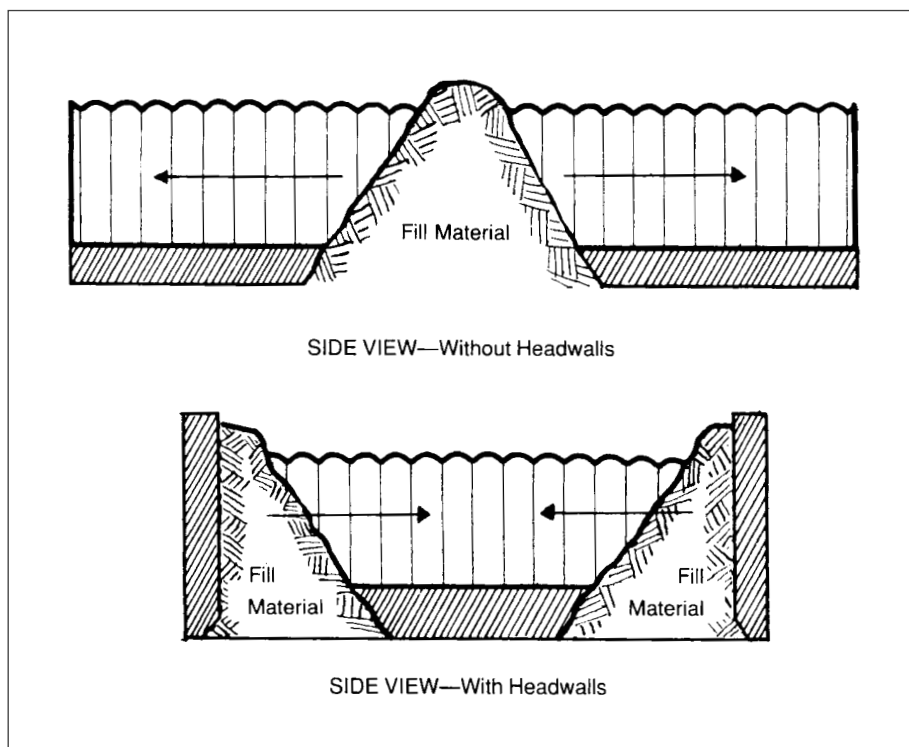

■ **Figure 10.25** Recommended backfilling direction depending on presence of end walls.

### Important Considerations During Compaction

#### Construction Loads

During the construction phase it is sometimes necessary for heavy construction equipment to travel over installed corrugated steel structures during completion of grading, paving or other site work. Heavy construction equipment can impose concentrated loads far in excess of those the structure is designed to carry.

Construction depth-of-cover tables are based on extensive research, as well as experience and fundamental design principles. However, it must be emphasized that the listed minimums may not be adequate during the construction phase because of higher live loads



from construction equipment. When construction equipment with heavy wheel loads, greater than those for which the pipe was designed, is to be driven over or close to the structure, it is the responsibility of the installer to provide the additional cover needed to prevent pipe damage. Table 10.1 provides minimum cover guidelines. Steel box culverts are especially vulnerable to damage from excessive live loads and may require additional temporary cover.

**Table 10.1**

Guidelines for minimum cover for heavy off-road construction equipment.				
Span (in)	Min. Cover (ft) for Axle Loads (kips)			
	18-50	50-75	75-110	110-150
12-42	2.0	2.5	3.0	3.0
48-72	3.0	3.0	3.5	4.0
78-120	3.0	3.5	4.0	4.0
126-144	3.5	4.0	4.5	4.5

1) Min. crossing width of twice the span is recommended.  
2) Additional cover may be needed depending on local conditions.

The amount of additional fill needed depends on the equipment axle loads as well as rutting and frequency of use. Figure 10.26 provides safe minimum cover limits for typical structure sizes, axle loads and construction use. This figure does not apply to steel box culverts. The additional temporary cover shown in Figure 10.26 must be maintained so that rutting, surface grading, etc. does not reduce its effect. A minimum crossing width of twice the structure span (or total width for multiple structures) is recommended for typical equipment.

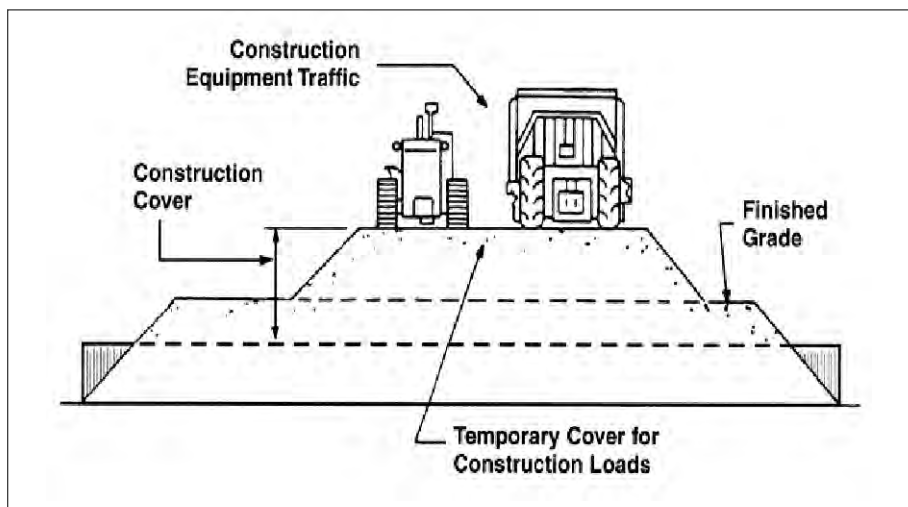

■ **Figure 10.26** Minimum cover for construction loads. (See also Figure 10.42.)

### Minimum Cover

When the fill on both sides approaches the top of the structure, the same techniques of spreading shallow layers and compacting thoroughly must be continued as the fill covers the pipe. For the initial layers over the pipe, use of light compaction equipment working across the pipe is recommended.

After minimum cover requirements for the equipment used have been reached, and the structure is locked into place, further filling to grade may continue, using procedures applicable to regular trench or embankment construction.

### Shape Control

Shape control refers to controlling the symmetry of the structure during backfill, by control of the backfill operation. Two movements may occur during backfill - "peaking", caused by the pressure of the compacting side-fills, and "rolling", caused by unbalanced fill or greater compaction on one side as shown in Figure 10.27.

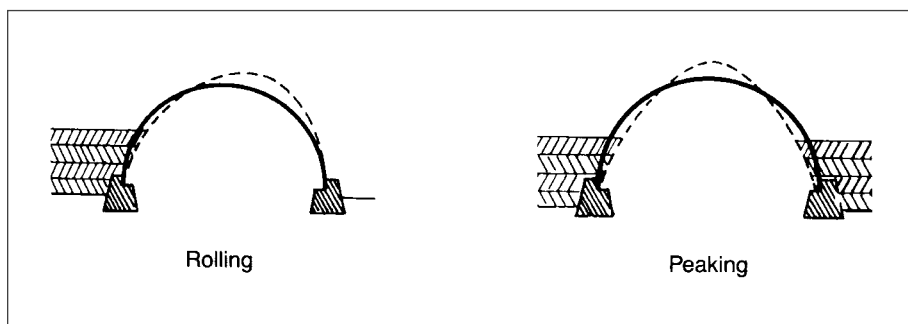

■ **Figure 10.27** Rolling and peaking.

As a general rule, deflection in any direction, measuring greater than 2% from original shape, should not be allowed during the backfill operation. The plumb bob method of deflection monitoring (Figure 10.28) is convenient and effective. Suspend plumb bobs, prior to backfilling, from the shoulder (2 and 10 o'clock) positions so that the points of the bobs are a specific distance above a marked point on the invert. Peaking action can be detected when the points of the bobs move upwards. Corrective action is to keep equipment further away from the structure and/or to be cautious during compaction effort. It is unlikely that peaking will become severe, except for structures with long radius sides (i.e. vertical ellipses, medium and high profile arches, and pear or horse shoe shapes).

Rolling (racking) action can be detected when the plumb bobs move laterally. Early on this is corrected by filling or compacting on the side towards which the plumb bob has moved. For example, a roll to the right will be corrected by placing a higher fill level on the right. Careful monitoring of the plumb bobs and prompt remedial steps prevent excessive peaking or rolling action from distorting the structure.

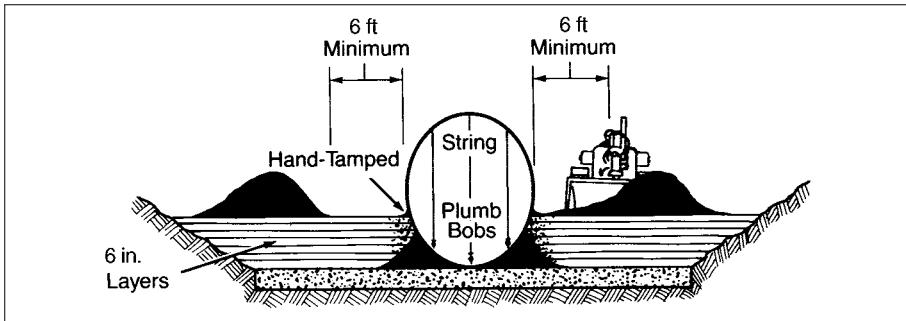

■ **Figure 10.28** Backfilling with plumb bob monitoring.

If distortion greater than what is allowable occurs, backfill should be removed and replaced. The steel structure will usually return to its original shape, unless distortion has been excessive. Shop-cut bevel and skew ends act as cantilever retaining walls and may not be able to resist the lateral pressures caused by heavy equipment and vigorous compaction. Temporary horizontal bracing should be installed across beveled or skewed ends before backfill commences if heavy equipment is to be used close to the cut ends. Alternatively, heavy equipment should be kept away from the cut ends of the pipe. The larger the rise of the structure, the more important this becomes.

### Vertical Deflection

The sides of a flexible structure will naturally push outward resulting in compaction of the side-fills and mobilizing their passive resistance. As the sides go outward, the top moves downward (Figure 10.3). This downward vertical deflection is normal. With reasonable backfill practice, any flexible underground structure can be expected to deflect vertically. With excellent practice, the deflection is usually less than 2% of the rise dimension.

If the side-fills are placed loose and/or not compacted, the sides of a flexible structure will move outward to a point where the vertical deflection increases the radius of the pipe crown to the point that pipe failure may occur by buckling. For smaller diameter round pipes, experience has shown that complete vertical (snap-through) buckling failure may occur at 20% to 30% vertical deflection.

Positive soil arching usually occurs over flexible structures with depths of cover greater than the pipe diameter. If the column of fill over the pipe settles slightly more than the side-fills, some of the weight of this column is effectively transferred to the side-fills through shear. In the process, a positive soil arch is mobilized, which reduces the effective load on the structure. Once again, correct installation and backfilling are required for this to occur. The height of cover tables in Chapter 7 assume some soil arching.

### Pipe Arch Backfill

Pipe arches require special attention to the backfill material and compaction around the corners. A large proportion of the vertical load over the pipe is transmitted into the soil at the corners (Figure 10.9 in this chapter). The backfill adjacent to pipe arch corners must provide at least 4,000 psf of bearing resistance. In the case of high fills, deep trenches, or soft native soils, a special design may be required for corner backfill zones. Round pipe is recommended in these conditions, rather than the pipe arch shape.

### Multiple Barrel Installations

When two or more steel drainage structures are installed in parallel lines, the space between them must be adequate to allow proper backfill placement, haunching and compaction. The minimum spacing requirement depends upon the shape and size of the structure as well as the type of backfill material. Figure 10.29 provides recommended minimum spacing for pipe, pipe arch and arches when standard backfill materials are used. The minimum spacing provides adequate room to fill under the haunches and to compact the backfill.

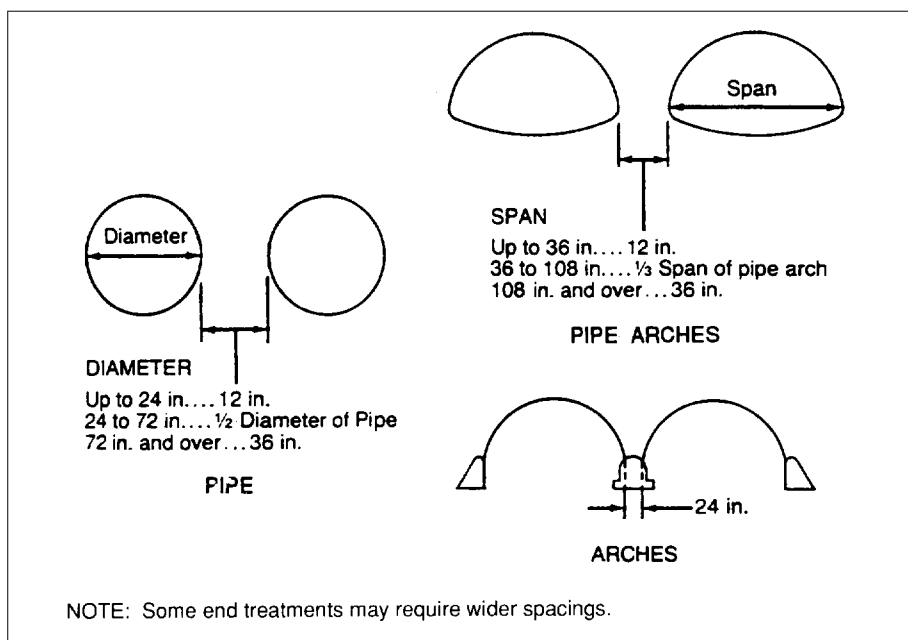

■ **Figure 10.29** Minimum permissible spacings for multiple installations.

Minimum spacing can be reduced somewhat when crushed rock or other backfill materials are used that flow easily (into the haunch) and require little compaction. Spacings of 18 inches or less can be used with backfill materials such as crushed rock, #57 stone or pea gravel. These materials are easier to place in the haunches. When necessary, concrete

vibrators can be used to move and consolidate the backfill, much like they do fluid concrete, to assure that there are no voids remaining. When controlled low strength material (CLSM) is used as backfill, the spacing restriction is reduced to the spacing necessary to place the grout between the structures. Regardless of the material, backfilling between and outside the structure cannot be done independently. Rather, backfilling must proceed jointly to maintain a balanced load.

Whether the structures are large or small, the room required for compaction equipment also should be considered in determining spacing between structures. For example, with structural plate structures it may be desirable to utilize mobile equipment for compaction between structures. The space between pipes should allow efficient operation of tamping equipment. Where these limits on structure spacing are cumbersome, use of CLSM between structures often can reduce the spacing requirements to the few inches required for hoses, etc. to place the backfill or the space needed to physically join or assemble the pipes, whichever is greater. There is additional discussion on multiple barrel installations in the detention system section later in this chapter under the heading, Detention, Retention and Recharge Structures.

### **Flotation**

When CSP relined pipes or those backfilled with grout are installed, a primary consideration is the need to control flotation. Fluid grout, which may have a density of 120 pcf or greater can develop greater buoyancy forces than water. To minimize flotation problems, grout is typically placed in thin lifts from side to side of the pipes in a balanced manner.

When it is necessary to place the fluid grout in lifts that produce more buoyant force than the weight of the pipe, the pipe must be held in place. Methods to hold relined pipes down typically include interior bracing against the host structure (see Chapter 12).

Direct burial pipes typically are more difficult to hold down. Techniques that have been used to provide a degree of hold down restraint include placing timbers over the pipe with each end wedged into the trench wall, or placing tension straps over the pipe crown tied to earth anchors in the foundation. Where feasible, pipes have been filled with water or weighted down with concrete blocks placed on roller dollies in the invert. Where the hold down restraints are intermittent, support spacing limits apply such as discussed for aerial spans in Chapter 8. However, it must be recognized that the aerial span limits apply to water filled pipes whereas inundating the entire pipe with grout could develop roughly twice the uplift, due to the higher grout density.

One way to reduce the buoyant forces is the use of CLSM or lightweight cementitious backfill materials. This material is often Portland cement, water and a foaming agent that, at 30 to 40 pounds per cubic foot, provide excellent backfill and lower buoyancy forces than a low strength slurry.

### Backfill Summary

In summary, the key points in the backfilling operation are:

- Use good backfill material.
- Ensure good backfill and adequate compaction under haunches.
- Maintain adequate width of backfill.
- Place material in thin, uniform, layers.
- Balance fill on either side of the structure as backfilling progresses.
- Compact each layer before adding the next layer.
- Monitor design shape and modify backfill procedures if required.
- Do not allow heavy equipment over the structure without adequate cover protection.
- Special considerations include multiple radius shapes (pipe arches, underpass, etc.), multiple barrel installations and detention/retention structures.

### End Treatment

In many installations, the ends of corrugated steel pipe that project through an embankment can be simply specified as square ends; that is, not beveled or skewed. The culvert length can be increased to accommodate slopes to the bottom of the square end of the pipe. Many times this is the least expensive end treatment. The protection of the soil face should be considered during construction so that erosion is limited. The square end is lowest in cost and readily adaptable to road widening projects. For larger structures, the slope can often be warped around the ends to avoid severe skews or bevels on the pipe end. When desired for hydraulic considerations, flared steel end sections (Figure 10.30) can be furnished for shop fabricated pipe. Such end sections are bolted directly to the pipe. Pre-manufactured end sections are further described in Chapter 2. Precast concrete headwall sections that include a corrugated steel pipe stub can also be specified to protect and enhance pipe ends.



■ **Figure 10.30** Corrugated steel pipe arch flared steel end sections.

When specified, ends of corrugated steel structures can be cut (beveled or skewed) to match the embankment slope as seen in Figure 10.31. However, as indicated in Chapter 7, cutting the ends destroys the ability of the end portion of the structure to resist ring compression forces. Thus, ends with severe cuts must be reinforced, particularly on larger structures. For more complete information see Chapter 7. Cut ends are usually attached to headwalls or ring beams with  $3/4$ " diameter anchor bolts spaced at about 18 inches. (See Chapter 2)



■ **Figure 10.31** Multiple line CSP beveled ends.

The maximum angle permissible for un-reinforced skew cut ends is dependent on the pipe span (or for multiple runs, their combined span) as well as the fill slope. Greater spans or steeper fill slopes limit the degree of skew that can be used without being reinforced with concrete headwalls or ring beams. For larger span structures and multiple structures, this limit is viewed in regard to maintaining a reasonable balance of soil pressures from side-to-side, perpendicular to the structure centerlines.

During backfill and construction of headwalls, the pipe ends may require temporary bracing to prevent excessive distortion. The embankment slope around the pipe ends can be protected against erosion by the use of a headwall, a slope pavement, engineered soft or hard erosion protection, stone riprap, or bags filled with dry sand-cement mixture. Steel sheeting, welded wire, bin-type retaining walls or gabion headwalls may also provide an efficient, economical solution.

## Construction Supervision and Control

As in all construction activities, the owner should assign a knowledgeable member of the team to supervise the work in progress, and an inspector to ensure the installation is being performed to specification or accepted practice.

Standard small CSP culverts (6 inches to 60 inches diameter) should be checked at the foundation, bedding, haunches, spring line and minimum cover stages. Generally, con-

**SOIL-STEEL BRIDGE STRUCTURE  
CONSTRUCTION CONTROL FORM**

Owner \_\_\_\_\_ Location \_\_\_\_\_

Supervising Engineer and/or Auth./Rep. \_\_\_\_\_

Contract Firms and Supervising Personnel \_\_\_\_\_

\_\_\_\_\_

Design Engineer \_\_\_\_\_

Geotechnical Assessment \_\_\_\_\_

Stage Inspection	Dates of Inspection	Action-Date and Time of Stage Approval	Authorization to Next Stage
1. Foundation			
2. Bedding			
3. Erection			
4. Backfill-Haunches			
5. Backfill to Spring Line			
6. Backfill to Crown			
7. Backfill to Min. Cover			

Note:

It is suggested that the above form be attached to the certificate of final inspection, and that "as-constructed" drawings be based on cross-section and deflection surveys at least six months after reaching profile grade. (Note: This is a typical control document only.)

■ **Figure 10.32** Typical inspector's document for construction control of large corrugated steel pipe structures.



struction records need not be kept for CSP in this size range. Larger CSP (72 inch diameter and larger) and Structural Plate Pipe should have inspection at all stages of assembly and installation. Documentation of approval by the authorized inspector should be provided for each stage of construction. Stage inspection means that the contractor is required to have work inspected at specific points of progress, and to secure authorization to proceed to the next stage, in writing. A typical stage inspection form is shown in Figure 10.32.

Soil-steel structures with spans greater than 20 feet should have knowledgeable, on-site inspection personnel, authorized to accept or reject procedures or equipment. These engineered structures should be accorded the same degree of inspection and control as is given conventional bridge construction, which is recognized universally as a specialized discipline in engineering and contracting.

## DETENTION, RETENTION AND RECHARGE STRUCTURES

### Introduction

Foundation, trenchwall, bedding and backfill considerations for multiple barrel detention systems are not unlike those for conventional CSP installations. However, placement and compaction considerations differ substantially. Construction often must proceed in a different manner making the use of different materials and methods advisable to achieve a sound, economical result. While this design manual covers many of the procedures that must be followed, there may be cases that require additional considerations. It is always good practice to consult with the manufacturer prior to the installation of these systems.

The following are areas that should be considered and planned for each system installed:

- Foundation
- Bedding
- In-situ trench wall
- Backfill material
- Backfill placement
- Construction loading

### Foundation Considerations

A stable foundation must be constructed prior to the placement of the bedding material (Figure 10.32). It is important that the foundation is not only capable of supporting the design load applied by the pipe and its adjacent backfill weight, but is also capable of maintaining its integrity during the construction sequence (Figure 10.33).

When soft or unsuitable soils are encountered, corrective measures must be taken. The unsuitable material needs to be removed down to a suitable depth and then built up to the appropriate elevation with a suitable structural backfill material.

It is important to make sure that this added structural fill material has a gradation that will not allow the migration of fines, causing possible settlement of the detention system or the pavement above. In cases where the structural fill material is not compatible with the underlying soils, an engineering fabric can be used as a separator.



■ **Figure 10.33** Detention system installation.

The foundation subgrade should be graded to a uniform or slightly sloping grade prior to the placement of the bedding material. If the subgrade is a clay or is relatively non-porous and the construction sequence will last for an extended period of time, it is best to slope the grade to one end of the system. This will enable excess water to be drained quickly, preventing saturation of the subgrade.

### Bedding Considerations

A well-graded granular material placed a minimum of 4 to 6 inches in depth works best for the bedding (Figure 10.34). If construction equipment is expected to operate for an extended period of time on the bedding, an engineering fabric can be used to make sure the bedding material maintains its integrity.

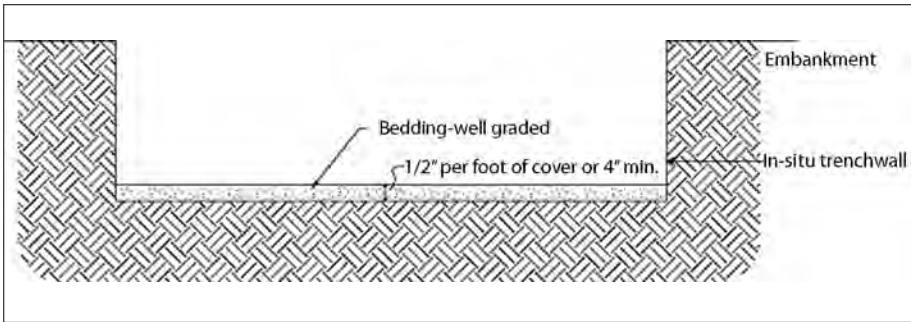

■ **Figure 10.34** Bedding considerations

The use of an open graded bedding material is acceptable; however, an engineering fabric separator is required between the bedding and the subgrade. The bedding should be graded to a smooth consistent uniform grade to allow for the placement of the pipe on the proper line and grade.

### In-Situ Trench Wall Considerations

In the event that excavation is required to get the pipe placed on the proper line and grade, consideration needs to be given to the quality of the surrounding in-situ soil (Figure 10.35). The trench wall must be stable and capable of supporting the load that the pipe sheds as the system is loaded. Soils that are weak and not capable of supporting these loads will allow the pipe to deflect excessively. A simple soil pressure check will provide the designer with the applied loads that can be used to determine the limits of excavation required beyond the spring line of the outermost pipes. It should be noted that in most cases, the requirements for providing a safe work environment and enough space for proper backfill placement and compaction, take care of this concern.

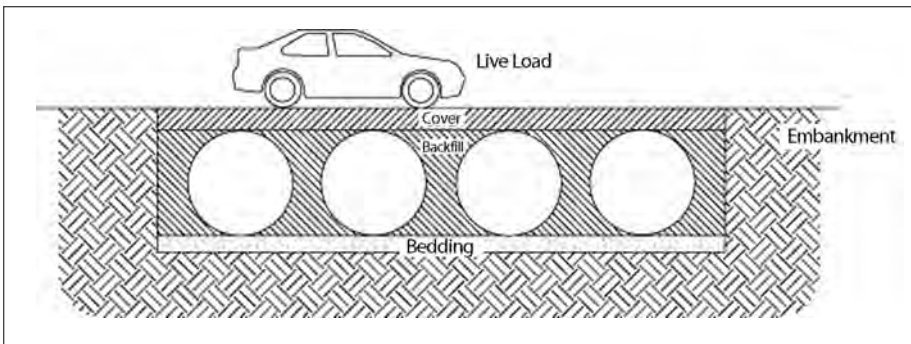

■ **Figure 10.35** In-Situ trench considerations

## Backfill Material Considerations

All other considerations aside, the best backfill material is an angular, clean, well-graded granular fill meeting the requirements of AASHTO A-1-a. However, other backfill types can be used (consult the manufacturer). If a uniformly graded (particles all one size) bedding is used, then a geotextile separation fabric should be used to prevent the migration of fines (Figure 10.36).

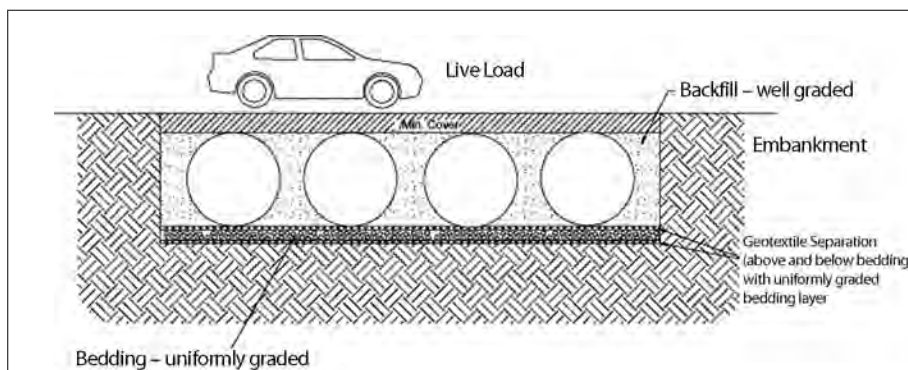

■ **Figure 10.36** Backfill considerations

Depending on the size of the pipe and the spacing, it is at times desirable to use a uniformly graded material for the first 18 to 24 inches. This type of material is easier to place under the haunches of the pipe and requires little compaction effort. In the event that this type of material is used, then a separation geotextile should be used above and below these initial lifts, depending again on the bedding material (Figure 10.37).

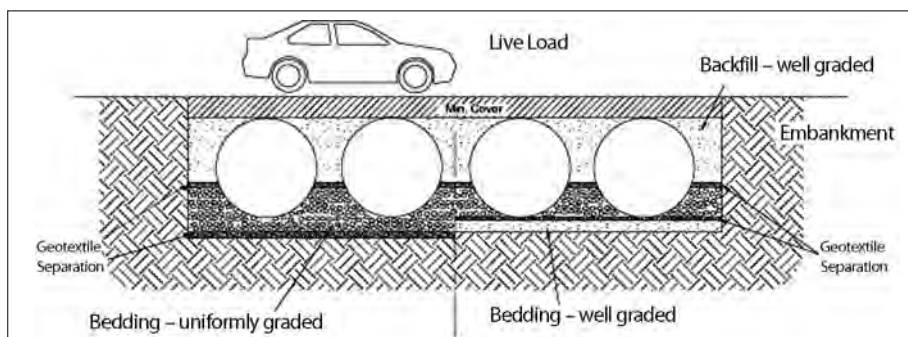

■ **Figure 10.37** Geotextile separator recommendations

It is not desirable to use an open graded fill beyond the initial 18 to 24 inches because the proposed fill often does not provide adequate confining restraint to the pipes in these types of systems.

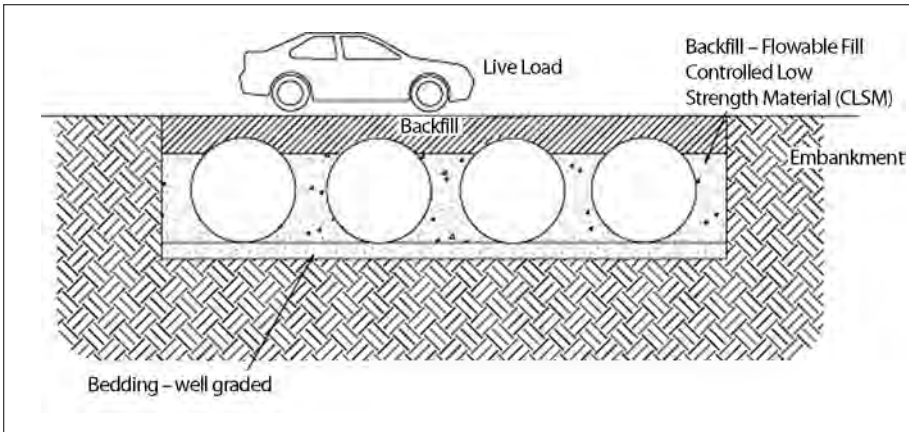

■ **Figure 10.38** Backfill with CLSM

Figure 10.38 shows backfill with CLSM, another suitable material.

### Backfill Placement Considerations

The backfill should be placed in 6 inch loose lifts and compacted to 90% AASHTO T99 standard proctor density (Figure 10.39). The backfill must be placed in a balanced manner making sure that no more than a two-lift differential is present from one pipe side to the other during the backfilling process. Excessive backfill differential heights from one side of the pipe to the other can cause pipe distortion or lateral movement.

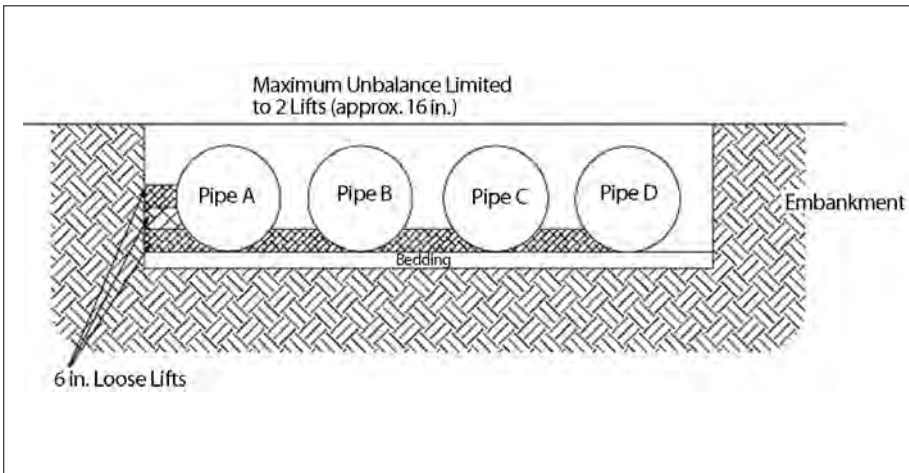

■ **Figure 10.39** Backfill placement

As backfill is placed between the pipes it must be kept balanced from side to side as well as advanced at the same rate along the length of the detention system. In other words, if you place the first lift between pipe A and B for a distance of 25 feet along the length of

the system, then 25 feet of fill needs to be placed between pipes B and C and so forth until all pipes are backfilled equally (Figure 10.40).

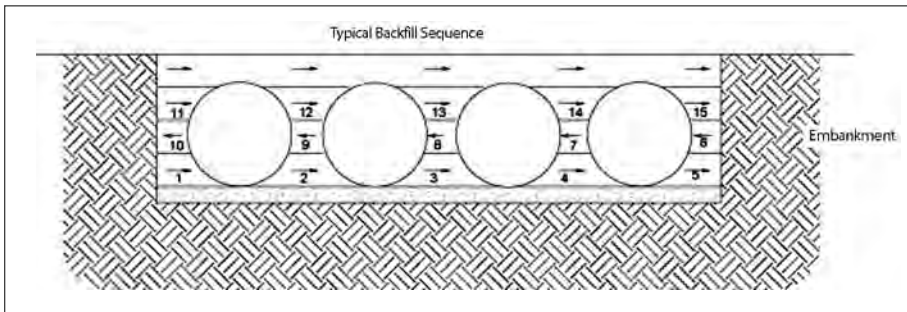

■ **Figure 10.40** Backfill placement sequence

For large systems, conveyor systems have been used to place the fill effectively. Backhoes with long reaches or draglines with stone buckets have also been used effectively to place the fill along the pipe lengths until minimum cover is reached for construction loading across the entire width of the system. On long parallel sections of pipe, the contractor may need to backfill in stages along the pipe lengths. Once the required cover is reached on the initial section, then the equipment advances forward to the end of the recently placed fill and the sequence begins over again until the system is completely backfilled. This type of construction sequence will provide room for stockpiled backfill directly behind the backhoe as well as for the movement of construction traffic. Material stockpiles on top of the backfilled detention system should be limited to 8-10 feet maximum height and must provide balanced loading across all barrels. To determine the proper cover over the pipes to allow the movement of construction equipment, see the section that follows, **Construction Loading Considerations**.

The trench width and pipe spacing requirements were established to allow the full range of backfill materials to be used. These spacings can be reduced when special backfill and special care is used. The limit is where the difficulty of access for assembly and backfill compaction becomes uneconomical.

Reducing the spacing between pipes can be especially helpful where the multiple runs often involved with detention, retention and recharge systems are encountered. These are typically low cover applications where the strength of the backfill is less important and high compaction not as critical. Clean, non-plastic, easily flowing backfill materials have higher strengths than other backfill materials, even at lower compaction levels.

Spacings of 24 inches are generally not objectionable. A spacing of 18 inches or less can be used with backfill materials such as crushed rock, # 57 stone or pea gravel. These materials are more easily placed into the haunch. When necessary, concrete vibrators can be used to move and consolidate the backfill much like they do fluid concrete, to assure there are no voids left. Alternatively conventional vibratory compaction plates have been

used inside the pipe invert to help move and consolidate these materials against the outside of the pipe.

Low strength grout, controlled low strength materials (CLSM), etc. allow spacing of as little six inches if the pipes can be joined. However, flotation becomes a special consideration and may require the pipe to be weighted (Figure 10.41).

### Flotation

When CSP reline pipes or those backfilled with grout are installed, a primary consideration is the need to control flotation. Fluid grout, which may have a density of 120 pcf or greater can develop greater buoyancy forces than water. To minimize flotation problems, grout is typically placed in thin lifts from side to side of the pipes in a balanced manner.

Direct burial pipes typically are more difficult to hold down. Methods that have been used to provide a degree of hold down restraint include placing timbers over the pipe with each end wedged into the trench wall, or placing tension straps over the pipe crown tied to earth anchors in the foundation. Where feasible, pipe have been filled with water or weighted down with concrete blocks placed on roller dollies in the invert.

Where the hold down restraints are intermittent, support spacing limits apply such as discussed for aerial spans in Chapter 8. However, it must be recognized that the aerial span limits apply to water filled pipes whereas inundating the entire pipe with grout could develop roughly twice the uplift, due to the higher grout density.

One way to reduce the buoyant forces is the use of lightweight cementitious backfill materials. These are often simply portland cement, water and a foaming agent that, at 30 to 40 pounds per cubic foot, provide excellent backfill and lower buoyancy forces than low strength grout. While these special backfill are more costly, the closer pipe spacings reduce the necessary quantity.

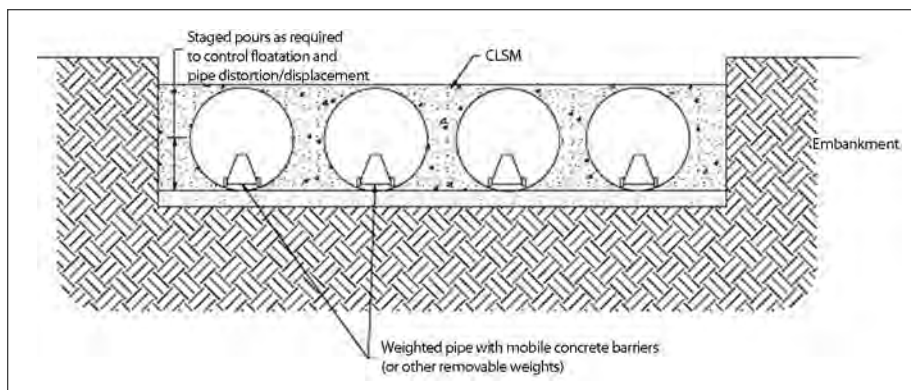

■ **Figure 10.41** Stage pours for CLSM placement



■ Box culvert with construction equipment loading on top of the structure.

## Construction Loading Considerations

Typically, the minimum cover specified for the project is for standard AASHTO H-20 live loads. Construction loads can greatly exceed those loads for which the pipe is designed in its completed state. In many cases, increased temporary minimum cover requirements are necessary to facilitate construction loading (Figures 10.26 and 10.42). Since construction equipment varies from job to job, it is best to discuss the minimum cover requirements during construction with the contractor at the preconstruction meeting. Table 10.1 provides guidelines.

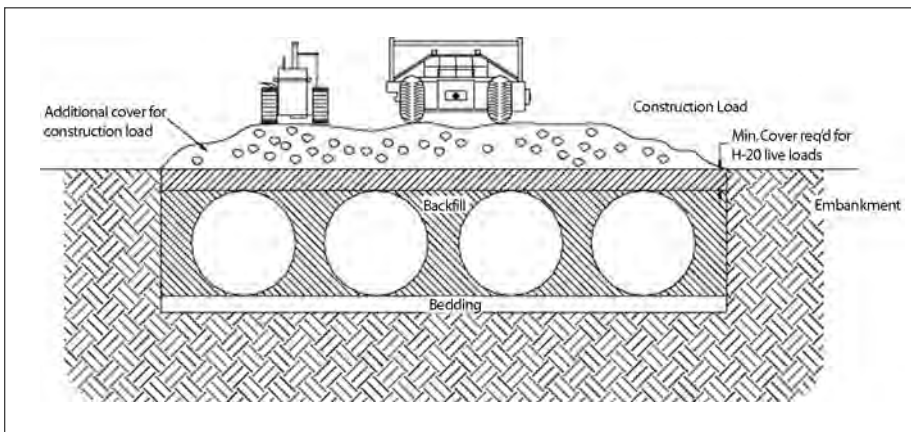

■ **Figure 10.42** Additional cover for construction loading



### Special Considerations

Since most of these systems (detention, retention, and recharge structures) are constructed at a grade below elevation for the surrounding site, rainfall can cause the excavation to fill with water rapidly. This rapid influx of water can potentially cause floatation and movement of the previously placed pipes. To help mitigate potential problems, it is best to start the system at the outlet or down stream end with the outlet already constructed to allow a route for the water to escape. Temporary diversion measures to handle flow may be required due to the restricted nature of the outlet pipe.

## FIELD ASSEMBLED STRUCTURAL PLATE STRUCTURES

Structural Plate Corrugated Steel Pipe (SPCSP) differs from shop fabricated pipe in that the structure is shipped in unassembled steel plates to the jobsite. Structures larger than what can traditionally be shipped are easily assembled at the project site. Structural plate structures have an advantage over shop fabricated pipe in that the steel plates that comprise them can be made from thicker material and with deeper corrugation profiles. Standard SPCSP structures are those that are comprised of a 6 inch x 2 inch, 15 inch x 5 1/2 inch or 16 inch x 6 inch corrugation profiles and do not fall under the long span category.

### Unloading and Handling

Plates for structural plate structures are shipped nested in bundles complete with bolts and nuts and the assembly drawings and instructions necessary for erection. Bolts are color coded for length identification. Bolts for every SPCSP structure are provided in two lengths. The longer length is required when three or four thicknesses of plate overlap.

Bundles are sized so that cranes, loaders, or other construction equipment already on the job are all that is needed for unloading. Normal care in handling is required to keep the plates clean and free from damage by rough treatment. Pre-sorting the plates as they are unloaded, on the basis of their radius and location in the structure is important. All plates are clearly marked so they can be easily sorted.

### Assembly Methods

A variety of assembly techniques are available to suit site conditions, as well as the size or shape of the structure. Maintaining the design shape must be a key objective during plate assembly.

There are four basic methods by which structural plate structures can be assembled:

- 1) **Plate-by-Plate Assembly** - The majority of SPCSP structures are assembled directly on the prepared bedding or footings in a single plate-by-plate erection sequence, commencing with the invert, then the sides, and finally, the top. This method is suitable for any size of SPCSP structure. Initially, structures should be assembled with as few bolts as possible. The curved surface of the nut is always placed against the plate. Three or four finger-tightened bolts near the center of each plate, along longitudinal and circumferential seams, are sufficient to hold the assembly in place. This procedure gives maximum flexibility until all plates are fitted into place.

After part of the structure has been assembled into its shape by partial bolting, the remaining bolts can be inserted and hand tightened. Always work from the center of a seam toward the plate corner. Alignment of bolt holes is easiest when bolts are loose.

After all the bolts are in place, tighten the nuts progressively and uniformly, starting a few rings behind the stair-stepped plate assembly. The operation should be repeated to be sure all bolts are tight.

If the plates are well aligned, the torque applied with a power wrench need not be excessive. A good fit of the plates is preferable to the use of high torque. Bolts should not be over tightened. They should be torqued initially to a minimum of 150 foot pounds and a maximum of 300 foot pounds. It is important that the initial torquing be done properly. In many structures, nuts may be on the outside, and re-torquing would not be possible after backfill.

In some applications, such as for pedestrian and animal underpasses, it is specified that all bolt heads should be on the inside of the structure, for safety and visual uniformity. If a paved or gravel invert is to be placed, it may be desirable to have the bolt ends protruding into the area to be covered.

After backfilling, the structure relaxes and the actual in-service bolt torque will decrease slightly. Depending on plate and structure movements, some bolts may tighten, and some may loosen over time. The degree of change in torque values is a function of metal thickness, plate match, and change of structure shape during backfilling. This is normal and not a cause for concern, should checks be made at a later stage.

- 2) **Component Sub-Assembly** - This is the pre-assembly of components of a ring, away from the bedding (Figure 10.43). The components are usually comprised of preassembled sections of the bottom plates, the side plates and the crown plates. This method is suitable for most soil-steel bridge installations. Component sub-assembly is often more efficient than the plate-by-plate

method. Its main advantage is that it permits simultaneous progress at more than one location at the site. The final assembly operation can be carried out at the same time as the sub-assembly operation.

Placing the invert components on a prepared shaped bedding poses a problem with bolt insertion and torquing for large radius inverts (i.e. pipe arch or horizontal ellipse in particular). Bolts can be pre-placed by the use of spring clips. Other methods, such as the use of magnets or access trenches, may be used. Experienced assemblers often preassemble sections of invert plates prior to placement, as long as this does not affect the placement of side and top plates.

During component assembly of larger SPCSP structures, it is important to maintain curvature and resist flattening due to torquing and weight of the sections. The invert component should be sized to the proper radius and chord length before the side assemblies are started. This can be controlled by horizontal sizing cables. As the side components are bolted in place, these cables should be moved to the spring line. Similarly, the sides should be held to the design shape, to effect top closure. When design shape is maintained during erection, the top sub-assembly should fit into place.

The sizing cables should be left in place until all other bolts are torqued. It is important that design shape and size be maintained throughout the backfill operation, with allowances for normal movement arising from backfill pressures.

The bolts in plate assembly components should be fully tightened prior to placement. This means that loose-bolting until the full ring is completed, is not possible. Therefore, it becomes important that components being bolted are aligned before torquing. Shape checks should be carried out during and after erection to be certain that the erected shape is within design tolerances. Necessary shape corrections must be carried out prior to proceeding with the backfill operation.

Additional bolt tightening may be required on large structures. Corner bolts control position, and the remaining nuts are torqued to mid-range (approx. 120 foot pounds). Once the structure is completed, and correct alignment of plates is assured, another pass may be made to fully torque to not more than 300 foot pounds before the next ring assembly is completed.

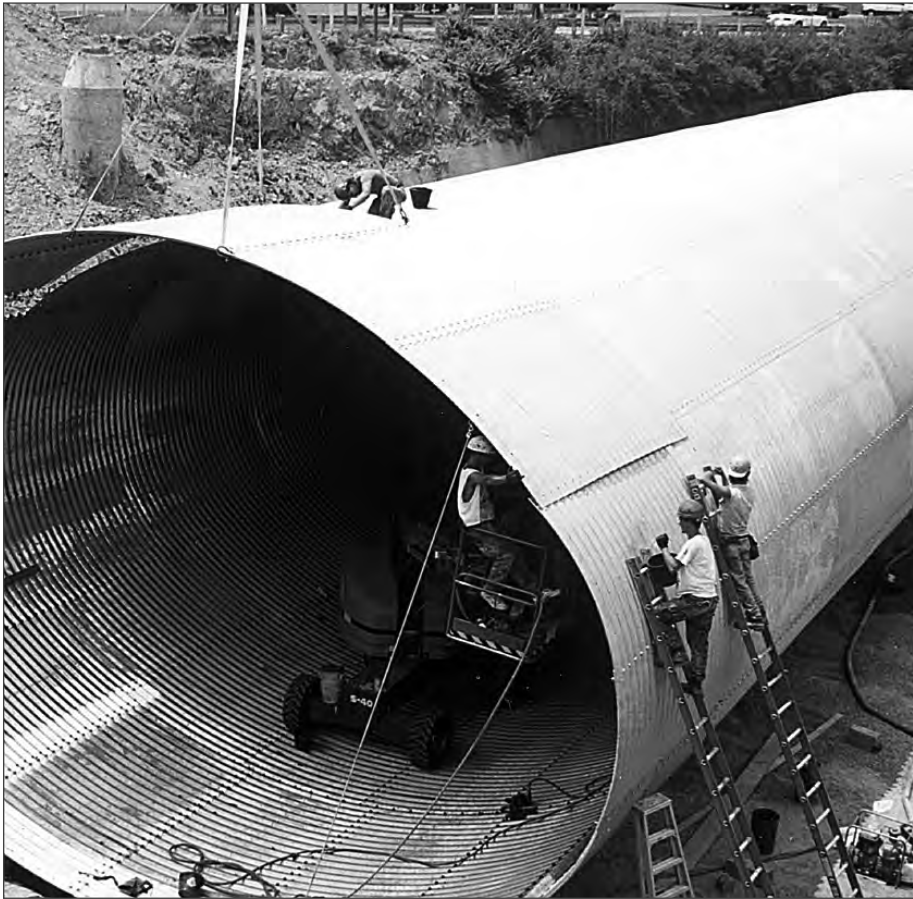

■ **Figure 10.43** Structure being completed with preassembled components.

- 3) **Pre-Assembly of Sections** - In this method, circumferential rings of round structures are assembled off-site. These rings, or cans, are then transported to the assembly site for connection along their circumferential seams. The end corrugations of one ring must be lapped with those of its adjoining ring, to provide continuity in the assembly.
  
- 4) **Complete Pre-Assembly** - Pre-assembly of the complete structure can be done either at the factory or at the jobsite. The factory pre-assembled method is used for relatively small span installations, this application being limited by shipping size. The field pre-assembly method is selected for structures to be lifted intact or to be skidded onto a prepared foundation and bedding. Pre-assembly techniques are essential for installation under submerged bedding conditions (Figure 10.44).



■ **Figure 10.44** Assembled structure being placed in position.

# Special Assembly Techniques

### Structural Plate Arches

Structural plate arch shapes differ from other plate structures in that the edges of the arch are erected on an abutment, or footing. The arch footings are usually constructed of poured-in-place concrete, but may also be timber sills or steel footing pads. The use of piling is not recommended, as this will introduce an unyielding foundation. If the entire soil-steel arch structure is allowed to settle with the foundation, this will avoid drag down loads on the arch and encourage positive soil arching and interaction.

The unbalanced steel channel on which the bottom plates rest must be located accurately as per the design drawings to ensure proper and easy plate assembly. Care must be taken to insure that the pre-punched holes in the two opposing channels are in accurate alignment. The installer must remember to cast the unbalanced channel at the correct angle and slope to accommodate the bottom plates. Improper placement of base channels can create serious problems in arch construction.

The layout for channel installation should be shown on the fabricator's plate assembly drawings. If accurate structure overall length is important, as it may be in pre-locating concrete headwalls, the designer should remember that the actual overall length is the net length plus 4 inches, due to the lips at the end of the end plates. Pre-locating headwalls is not a recommended practice due to the need to shape and support the headwall opening. This is further complicated by the flexible nature of these structures combined with manufacturing tolerances.

Scaffolding or temporary bracing of the early rings is usually necessary with the arch shape, as the initial plates are not self-supporting. Component pre-assembly is often advantageous.

### Structural Plate Pipe Arches

During the assembly of multiple radius structures such as pipe arches, underpasses and ellipses, care must be taken to ensure proper assembly and plate laps. Where different radius plates meet at a longitudinal seam, it may take extra effort to fully seat the corrugations and obtain the tangent plate lap required. Properly shaped bedding is especially important to assembly.

Pipe arches are currently fabricated in two forms. Some have multiple radius corner plates that include both corner and top radius elements. Others use separate corner and top plates with a longitudinal seam at this juncture. The plate lap arrangement differs with this type of fabrication. The manufacturer's assembly instructions should be followed to avoid improper plate laps.

## Other Structural Plate Considerations

### Asphalt Coating - Shop or Field Applied

Where structural plates require a protective coating in addition to galvanizing, there are suitable materials available for application to the components, to the assembled structure in the field, or on pre-assembled structures in the plant. Plates must be clean and dry. The coating can be asphalt mastic containing mineral fillers and stabilizers sprayed on under high pressure to a minimum thickness of 0.05 inches (AASHTO M-243 / ASTM A849).

### Seam Sealants

A degree of leak resistance for SPCSP structures can be achieved with modern seam sealants. Standard SPCSP structures, because of the bolted construction and lapped plates, are not intended to be watertight. On occasion, where a degree of water-tightness or prevention of soil infiltration is required, it is practical to insert a seam sealant tape within the bolted seams. The seam sealant normally specified is wide enough to cover all rows of holes in plate laps, and of the proper thickness and consistency to effectively fill the voids in plate laps.

The procedure for installing seam sealant is as follows:

- 1) The tape is rolled over each of the surfaces that will come in contact and worked into the corrugations. The tape should not be stretched.
- 2) Any paper backing must be removed prior to placing the lapping plates.
- 3) At all points where three plates intersect, an additional thickness of tape is placed for a short distance to fill the void caused by the transverse seam overlap.
- 4) A hot spud or a sharp tool dipped in machine oil is used to punch through the tape to provide a hole for inserting the bolts.
- 5) Tightening of the bolts twice is usually necessary to maintain adequate torque. As the seam sealant creeps under the pressure, final bolt torque will be lost. This is expected and not a concern. Plate fit-up and proper meshing is most important.

## Backfill and Compaction for Standard Structural Plate Sizes and Shapes

All of the backfill and compaction principles for CSP apply for structural plate with some additional considerations. Because the large structures are more flexible, shape control is especially important. The manufacturer of the structural plate product should always be contacted for additional information regarding backfill and compaction of structural plate structures.

### Backfill Material for Steel Structural Plate

Granular-type soils should be used as structural backfill (the soil envelope next to the metal structure). The order of preference of acceptable structure backfill materials is as follows:

- 1) Well-graded sand and gravel; sharp, rough, or angular if possible.
- 2) Uniform sand or gravel.
- 3) Mixed soils (not recommended for large structures).
- 4) Approved stabilized soil.

The structure backfill material should conform to one of the soil classifications from AASHTO Specification M-145 meeting the requirements of A1, A2 or A3. For heights of cover less than 12 feet, A-1, A-3, A-2-4 and A-2-5 or approved stabilized soils are recommended for long spans and box culverts only A1, A2-4, A2-5 and A3 are allowed. For heights of cover of 12 feet or more, A-1 and A-3 are suggested. For all structures with covers exceeding 20 feet requirements of A1 or A3 are desired.

The extent of the structure backfill zone is a function of the pressures involved and the quality of the foundation soils, the trench wall or embankment soil, and the fill over the structure. Figure 10.45 shows a typical backfill envelope.

### Arch Structure Backfill

Care must be taken in backfilling arches, especially taller arches (when the rise is greater than the span), because they have a tendency to shift sideways or to peak under backfilling loads. The ideal way is to cover an arch in layers with each layer conforming to the shape of the arch. If one side is backfilled more than the other, the arch will move away from the larger load. If both sides are backfilled equally and tamped thoroughly, the top of the arch may peak unless enough fill has been placed over it to resist the upward thrust. These precautions apply also to other corrugated steel structures, but to a lesser degree.

If the headwalls are built before the arch is backfilled as recommended, the backfill material should first be placed adjacent to each headwall, placing and compacting material uniformly on both sides of the structure until the top of the arch is reached. Then backfill should proceed toward the center by extending the ramp with care being taken to place and compact the material evenly on both sides of the arch. Top loading a small amount of backfill material will help prevent peaking.

When backfilling arches without headwalls or before headwalls are placed, the first material should be placed midway between the ends of the arch forming as narrow a ramp as possible until the top of the arch is reached. The ramp should be built evenly from both sides and the backfill material should be thoroughly compacted as it is placed. After the two ramps have been built to the depth specified to the top of the arch, the remainder of



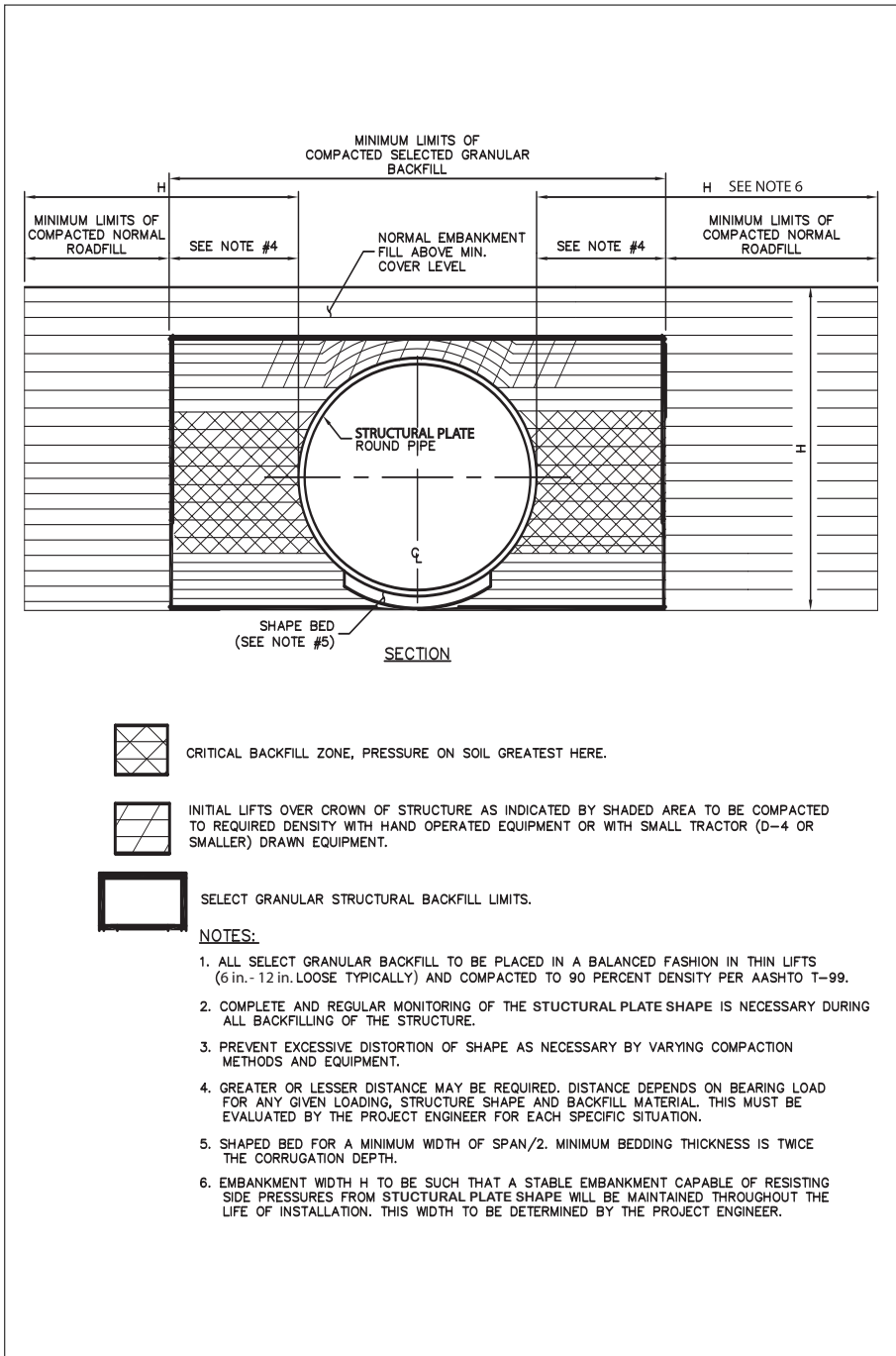

■ **Figure 10.45** Typical structural plate backfill envelope

the backfill should be placed and compacted by extending the ramp both ways from the center to the ends and as evenly as practical on both sides of the arch.

## SPECIAL STRUCTURAL PLATE SHAPES AND CORRUGATIONS

Special structural plate shapes and corrugations are those that don't fall under the standard plate category. Generally the manufacture and design of these structures are proprietary and the individual manufacturers should be contacted for further information regarding their products. This section is intended to be an overview of the special considerations typically needed in regards to these structures.

### Long Span Structures

Long span structures are unique from standard structural plate in two ways: longer spans and/or deeper corrugations. Long spans are available in spans up to 75 feet. Plate erection may differ from the recommendations for standard structures with added attention given to maintaining structural shape during assembly and backfill. Proper backfill materials and compaction are essential to structural integrity and should comply with instructions given under backfilling. Additional construction supervision and control is required for long span structures.

### Foundation

Long span structures are relatively light in weight and often have significant rise dimensions. Unless cover is significant, they exert lower bearing pressures on the foundation than the structural backfill materials beside the structure. Foundation bearing strength requirements generally relate to the need to support the side-fill without excessive settlement. If any relative settlement occurs, it is preferable that the structure settles relative to the side fill to avoid developing increased loads as a result of negative soil arching.

When a structure with a bottom is used, plates have relatively larger radii and exert limited pressure on the foundation. It is often only necessary to provide a uniform, stable foundation beneath the structure to support erection activities. For arch structures, footing designs must recognize the desired relative settlement conditions. The need for excessively large footings or pile supports is indicative of poor soil conditions and therefore, inadequate support beneath the side-fill.

### Bedding

Pipe arch, horizontal ellipse and underpass shapes with spans exceeding 12 feet should be placed on a shaped bed. The shaped area should be centered beneath the pipe and should have a minimum width of one-half the span for pipe arch and underpass shapes, and one-third the span for horizontal elliptic shapes. Preshaping may consist of a simple "V" graded into the soil.

### **Backfill**

While basic backfill requirements for long span structural plate structures are similar to those for smaller structures, their size is such that excellent control of soil placement and compaction must be maintained to fully mobilize soil-structure interaction. A large portion of their full strength is not realized until backfill (side-fill and overfill) is in place.

Of particular importance is control of structure shape. Equipment and construction procedures used should ensure that excessive structure distortion will not occur. Structure shape should be checked regularly during backfilling to verify acceptability of the construction methods used. The manufacturer will specify the magnitude of allowable shape changes.

The manufacturer should provide a qualified construction inspector to aid the engineer during all structure backfilling. The inspector should advise the engineer on the acceptability of all backfill materials and methods and undertake monitoring of the shape.

Structural backfill material should be placed in horizontal uniform layers not exceeding 8 inches thick before compaction and should be placed uniformly on both sides of the structure. Each layer should be compacted to a density not less than 95% per (Standard Proctor Density). The structure backfill should be constructed to the minimum lines and grades shown on the plans. Permissible exceptions to the structural backfill density requirement are: 1) the area under the invert; 2) the 12 to 18 inches width of soil immediately adjacent to the large radius side plates of high profile arches and inverted pear shapes; 3) and the first horizontal lift of overfill carried ahead of and under construction equipment initially crossing the structure.

### **Box Culverts**

Box culverts are treated differently than soil steel structures. They are very stiff compared to long span structures and this makes the placement and compaction of backfill materials easier.

#### **Assembly of Box Culverts**

Due to the stiffness requirements of a box culvert shape, some installations may require the addition of reinforcing ribs. The box culvert manufacturer should be consulted prior to assembly to insure the proper technique is followed for installation.

#### **Backfill of Box Culverts**

Box culverts require long span backfill materials (above) that are properly compacted in a zone that extends 3 feet on each side of the outside of the box and up to the minimum cover. The granular backfill material in the engineered backfill zone should be placed uniformly on both sides of the box culvert in layers not exceeding 8 inches in depth and compacted to a minimum of 95% Standard Proctor Density (ASTM D698). Compaction testing during construction is the responsibility of the contractor. The dif-

ference in the levels of backfill on the two sides, at any transverse section should not exceed 2 feet. The range of cover over steel box culverts is from 1.4 to 5 feet.

Heavy compaction equipment or backfill dump trucks that could alter the shape of the box culvert should be avoided. Heavy compaction equipment should not be allowed within 3 feet of the structure wall or close enough to cause distortion.

A non-woven geotextile should be placed at the ends of hollow or corrugated reinforcing ribs to prevent backfill from entering the cavity between the barrel and the reinforcing rib.

## CHAPTER SUMMARY

Proper installation of any drainage structure will result in longer and more efficient service. This installation and construction chapter is intended to call attention to both good practice and to warn against possible pitfalls. The principles apply to most drainage pipe materials. It is not a specification but an aid to your own experience.

### **The following items should be checked to insure proper installation:**

- (1) Check alignment and grade in relation to stream bed.
- (2) Make sure the length of the structure is correct.
- (3) Excavate to correct width, line and grade.
- (4) Provide a uniform, stable foundation.
- (5) Unload and handle structures carefully.
- (6) Assemble the structure properly.
- (7) Use a suitable backfill material.
- (8) Place and compact backfill as recommended.
- (9) Protect structures from heavy, concentrated loads during construction.
- (10) Proper end treatment placement can protect the soil at the ends of culvert from erosion.
- (11) Construction supervision should be considered for all installations, but most especially for the more critical or complex applications.
- (12) Review additional considerations for large or deeply buried structural plate structures

### BIBLIOGRAPHY

AASHTO, LRFD Bridge Design Specifications, American Association of State Highway and Transportation Officials, 444 N. Capitol St., N.W., Ste. 249, Washington, D.C. 20001

AASHTO, Standard Specifications for Highway Bridges, American Association of State Highway and Transportation Officials, 444 N. Capitol St., N.W., Ste. 249, Washington, D.C. 20001

AISI, Handbook of Steel Drainage & Highway Construction Products, American Iron and Steel Institute, 1101 17th St. N.W., Washington, D.C. 20036-4700

AISI, Modern Sewer Design, American Iron and Steel Institute, 1101 17th St. N.W., Washington, D.C. 20036-4700

AREMA, Engineering Manual, American Railway Engineering and Maintenance-of-Way Association, 8201 Corporate Drive, Ste. 1125, Landover, MD 20785-2230

ASTM, "Standard Practice for Structural Design of Corrugated Steel Pipe, Pipe Arches, and Arches for Storm and Sanitary Sewers and Other Buried Applications," A796/A796M, Annual Book of Standards, Vol. 01.06, American Society for Testing and Materials, 100 Barr Harbor Drive, P.O. Box C700, West Conshohocken, PA 19428-2959

ASTM, "Standard Practice for Installing Factory-Made Corrugated Steel Pipe for Sewers and Other Applications," A798/A798M, Annual Book of Standards, Vol. 01.06, American Society for Testing and Materials, 100 Barr Harbor Drive, P.O. Box C700, West Conshohocken, PA 19428-2959

ASTM, "Standard Practice for Installing Structural Plate Pipe for Sewers and Other Applications," A807/A807M, Annual Book of Standards, Vol. 01.06, American Society for Testing and Materials, 100 Barr Harbor Drive, P.O. Box C700, West Conshohocken, PA 19428-2959

NCSPA, Installation Manual for Corrugated Steel Pipe, Pipe Arches and Structural Plate, National Corrugated Steel Pipe Association, 14070 Proton Road, Suite 100, Dallas, TX 75244



■ **Figure 11.1** 48 inch diameter CSP being used to slip line failed 54 inch diameter concrete pipe. Class 5, on partially constructed PA DOT Project – Southern Expressway – near the Pittsburgh Airport.